

# Reference Manual

DOC. REV. 08/04/2015

## VL-EPM-V7

PC/104-Plus Video Expansion Module





[WWW.VERSALOGIC.COM](http://WWW.VERSALOGIC.COM)

12100 SW Tualatin Road  
Tualatin, OR 97062-7341  
(503) 747-2261  
Fax (971) 224-4708

Copyright © 2015 VersaLogic Corp. All rights reserved.

**Notice:**

Although every effort has been made to ensure this document is error-free, VersaLogic makes no representations or warranties with respect to this product and specifically disclaims any implied warranties of merchantability or fitness for any particular purpose.

VersaLogic reserves the right to revise this product and associated documentation at any time without obligation to notify anyone of such changes.

## Product Release Notes

**Rev 1.2** – Third release. Added PCI Slot information to Figure 5.

**Rev 1.1** – Second release. Replaced VGA connector with a PicoClasp connector for enhanced reliability.

**Rev 1.0** – Commercial Release.

## Support Page

The [VL-EPM-V7 Support Page](#) contains additional information and resources for this product including:

- Operating system information and links to software drivers
- Data sheets and manufacturers' links for chips used in this product
- BIOS and PLD information and upgrades
- Links to KnowledgeBase articles and product advisories

## Knowledgebase

The [VersaTech KnowledgeBase](#) is a useful resource for resolving technical issues with your VersaLogic product.

## Customer Support

If you are unable to solve a problem after reading this manual, visiting the product support page, or searching the KnowledgeBase, contact VersaLogic Technical Support at (503) 747-2261. VersaLogic support engineers are also available via e-mail at [Support@VersaLogic.com](mailto:Support@VersaLogic.com).

## Repair Service

If your product requires service, you must obtain a Returned Material Authorization (RMA) number by calling 503-747-2261. Provide the following information:

- Your name, the name of your company, your phone number, and e-mail address
- The name of a technician or engineer that can be contacted if any questions arise
- The quantity of items being returned
- The model and serial number (barcode) of each item
- A detailed description of the problem
- Steps you have taken to resolve or recreate the problem
- The return shipping address

**Warranty Repair** All parts and labor charges are covered, including return shipping charges for UPS Ground delivery to United States addresses.

**Non-warranty Repair** All approved non-warranty repairs are subject to diagnosis and labor charges, parts charges and return shipping fees. Specify the shipping method you prefer and provide a purchase order number for invoicing the repair.



### Note:

Mark the RMA number clearly on the outside of the box before returning.

# Contents

---

<b>Introduction .....</b>	<b>1</b>
Description.....	1
Technical Specifications .....	1
Block Diagrams.....	2
Cautions .....	4
Electrostatic Discharge.....	4
Handling Care .....	4
Earth Ground Requirement .....	4
<b>Physical Layout .....</b>	<b>5</b>
Dimensions and Mounting.....	5
Hardware Assembly .....	6
Stack Arrangement Example.....	7
External Connectors .....	8
Connectors.....	8
Connector Functions and Interface Cables.....	10
Jumper Summary.....	11
<b>Interfaces and Connectors .....</b>	<b>12</b>
Video .....	12
VGA Interface.....	12
LVDS Flat Panel Display Connector .....	13
LVDS to VGA Adapter .....	14
PCI Express Mini Card Socket.....	16
LED_WWAN#, LED_WLAN#, and LED_WPAN# Signals .....	17
<b>Appendix A – References.....</b>	<b>18</b>
<b>Appendix B – Technical Notes .....</b>	<b>19</b>
Drivers .....	19
BIOS Configuration.....	19

---

## Figures

---

Figure 1. PCIe Module Block Diagram .....	2
Figure 2. Video Module Block Diagram.....	3
Figure 3. PCIe Module Dimensions and Mounting Holes .....	5
Figure 4. Video Module Dimensions and Connectors .....	6
Figure 5. Stack Arrangement Example .....	7
Figure 6. VL-EPM-V7 Connectors – Top Side .....	8
Figure 7. VL-EPM-V7 Connectors – Bottom Side .....	9
Figure 8. Location of V2 Jumper Block .....	11
Figure 9. VL-CBR-2014 LVDS to VGA Adapter Card.....	14
Figure 10. LVDS Resolution Switch Positions .....	15
Figure 11. Location of D3 and D4 LEDs .....	17

## Tables

---

Table 1: Baseboard Connector Functions and Interface Cables.....	10
Table 2: Video Mini Card Connector Functions and Interface Cables.....	10
Table 3: V2 Jumper Block Configuration Summary .....	11
Table 4: Maximum Display Resolutions .....	12
Table 5: J1 VGA Connector Pinout.....	12
Table 6: LVDS Flat Panel Display Pinout .....	13
Table 7: LVDS Startup Resolution Switch Settings.....	15
Table 8: PCIe Mini Card Pinout .....	16
Table 9: Wi-Fi Mini Card LED Functions.....	17

## Description

The VL-EPM-V7 expansion module provides VGA and LVDS display outputs for PC/104-*Plus* embedded systems. A Mini PCIe expansion socket accommodates plug-in modules such as A/D convertors, Ethernet, Wi-Fi modems, MIL-STD-1553, and other devices. With a full industrial temperature rating and rugged construction, the VL-EPM-V7 is an ideal solution for embedded video applications in harsh, mobile, and remote environments.

- One VGA and one LVDS port
- One unpopulated PCI Express Mini Card interface with PCIe signaling. Compatible with Wi-Fi, MIL-STD-1553 bus, cell modem, Flash memory, and other PCIe Mini Card devices
- Pass-through ISA interface
- Rugged, latching connectors
- Industrial temperature operation
- RoHS-compliant
- Customization available

This I/O board is compatible with a variety of popular x86 operating systems including Windows, Windows Embedded, and Linux.

The module features high-reliability design and construction. VL-EPM-V7 boards are subjected to 100% functional testing and are backed by a limited five-year warranty. Careful part sourcing and US-based technical support ensure the highest possible quality, reliability, service, and product longevity for this exceptional module.

## Technical Specifications

See the [VL-EPM-V7 Data Sheet](#) for complete specifications.

## Block Diagrams

Figure 1 shows a block diagram of the VL-EPM-V7 expansion module. Figure 2 shows a block diagram of the video module.

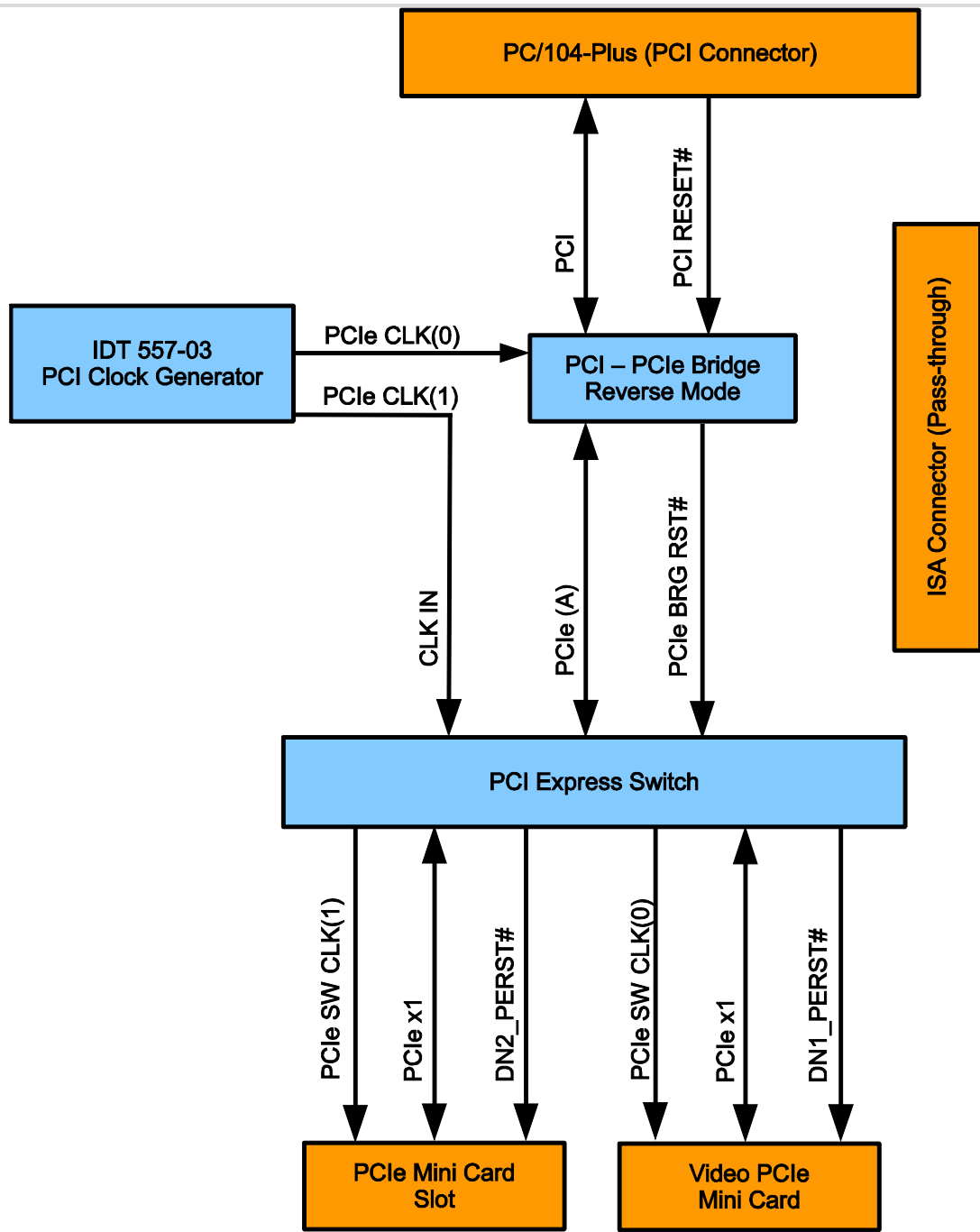

V7\_001

Figure 1. PCIe Module Block Diagram

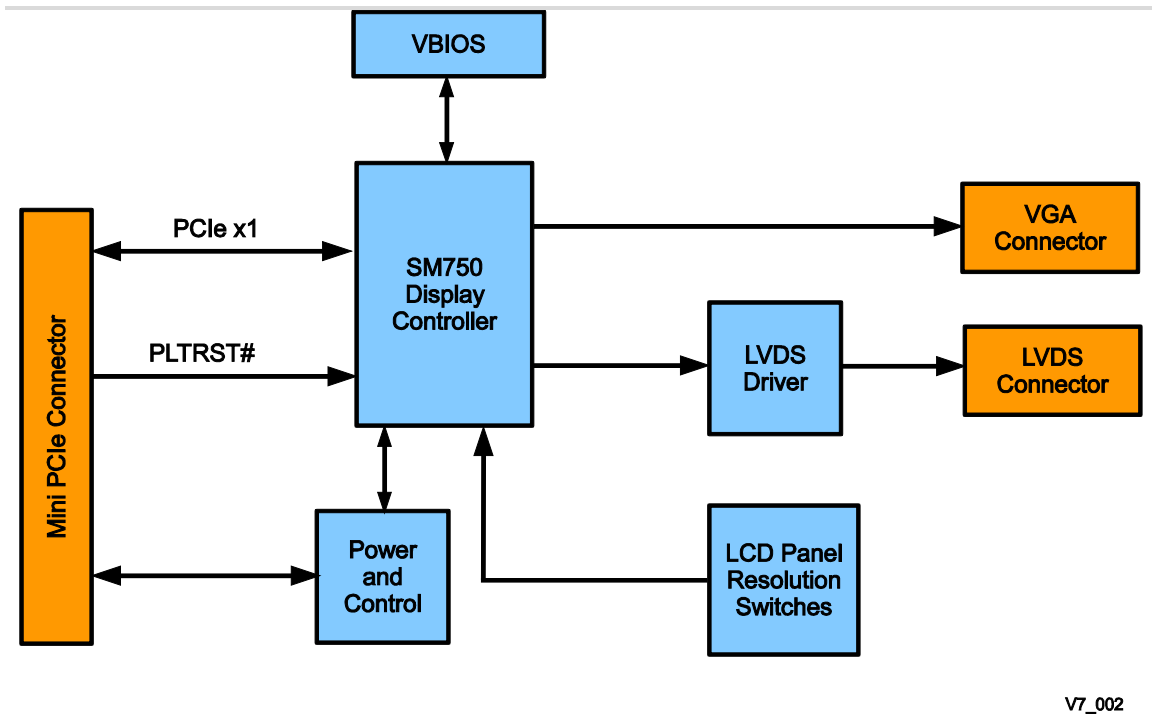

Figure 2. Video Module Block Diagram



## Cautions

### ELECTROSTATIC DISCHARGE

**CAUTION:**

Electrostatic discharge (ESD) can damage circuit boards, disk drives and other components. The circuit board must only be handled at an ESD workstation. If an approved station is not available, some measure of protection can be provided by wearing a grounded antistatic wrist strap. Keep all plastic away from the board and do not slide the board over any surface.

After removing the board from its protective wrapper, place the board on a grounded, static-free surface, component side up. Use an antistatic foam pad if available.

The board should also be protected inside a closed metallic anti-static envelope during shipment or storage.

**Note:**

The exterior coating on some metallic antistatic bags is sufficiently conductive to cause excessive battery drain if the bag comes in contact with the bottom-side of the product.

### HANDLING CARE

**CAUTION:**

Care must be taken when handling the board not to touch the exposed circuitry with your fingers.

### EARTH GROUND REQUIREMENT

**CAUTION:**

All mounting holes should be connected to earth ground (chassis ground). This provides proper grounding for ESD and EMI purposes. In portable applications, the mounting holes should be connected to the ground reference of the system power supply.

# Physical Layout

## Dimensions and Mounting

The VL-EPM-V7 complies with PC/104 dimensional standards. Figure 3 provides dimensions to help with pre-production planning and layout.

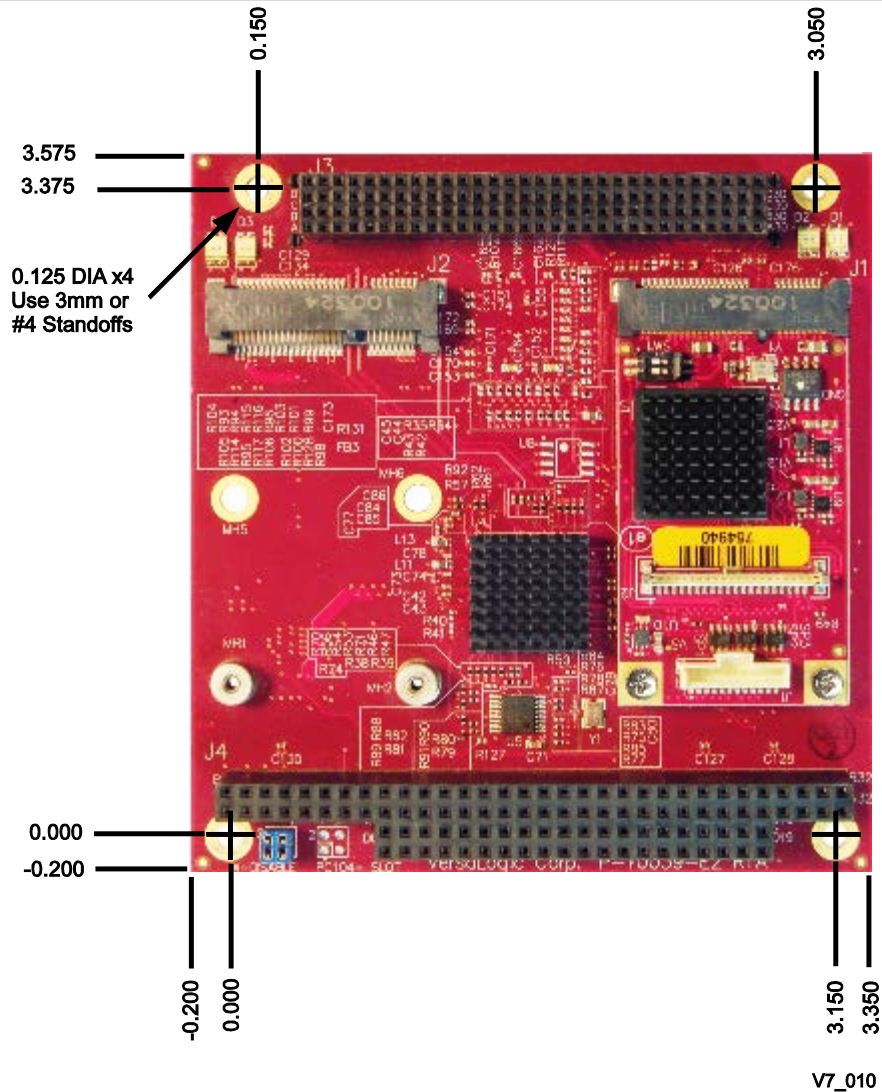

**Figure 3. PCIe Module Dimensions and Mounting Holes**  
(Not to scale. All dimensions in inches.)

The video module complies with MiniPCIe Mini Card (full size) dimensional standards. Figure 4 provides dimensions to help with pre-production planning and layout.

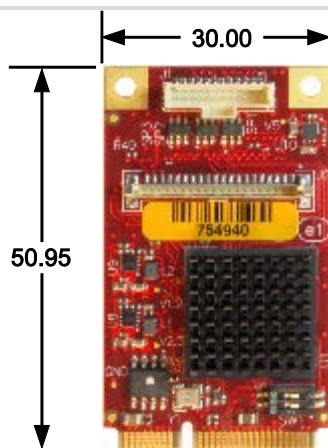

V7\_011

**Figure 4. Video Module Dimensions and Connectors**

*(Not to scale. All dimensions in millimeters.)*

## HARDWARE ASSEMBLY

The VL-EPM-V7 uses both PC/104-*Plus* (PCI + ISA) connectors. The module can be installed in PCI stack position 0-3. As shipped, the VL-EPM-7 is configured for position 0 (first on the stack adjacent to the CPU board). Make sure that jumper V2 matches the chosen stack position (see Jumper Summary, page 11). PC/104 (ISA) modules must not be positioned between the VL-EPM-V7 and any PC/104-*Plus* (PCI + ISA) modules on the stack.

The entire assembly can sit on a table top or be secured to a base plate. When bolting the unit down, make sure to secure all four standoffs to the mounting surface to prevent circuit board flexing. Standoffs are secured to the top circuit board using four pan head screws. Standoffs and screws are available as part number VL-HDW-105 (metric thread) or VL-HDW-106 (English thread).

An extractor tool is available (part number VL-HDW-201) to separate modules from the stack. Use caution when using the extractor tool not to damage any board components.

### STACK ARRANGEMENT EXAMPLE

Figure 5 shows the VL-EPM-V7 installed above the CPU board in the PC/104-Plus stack. The module can be installed in slots 0-3. Jumper block V2 must be configured to match the module's stack position. Refer to the section titled Jumper Summary on page 11 for more information.

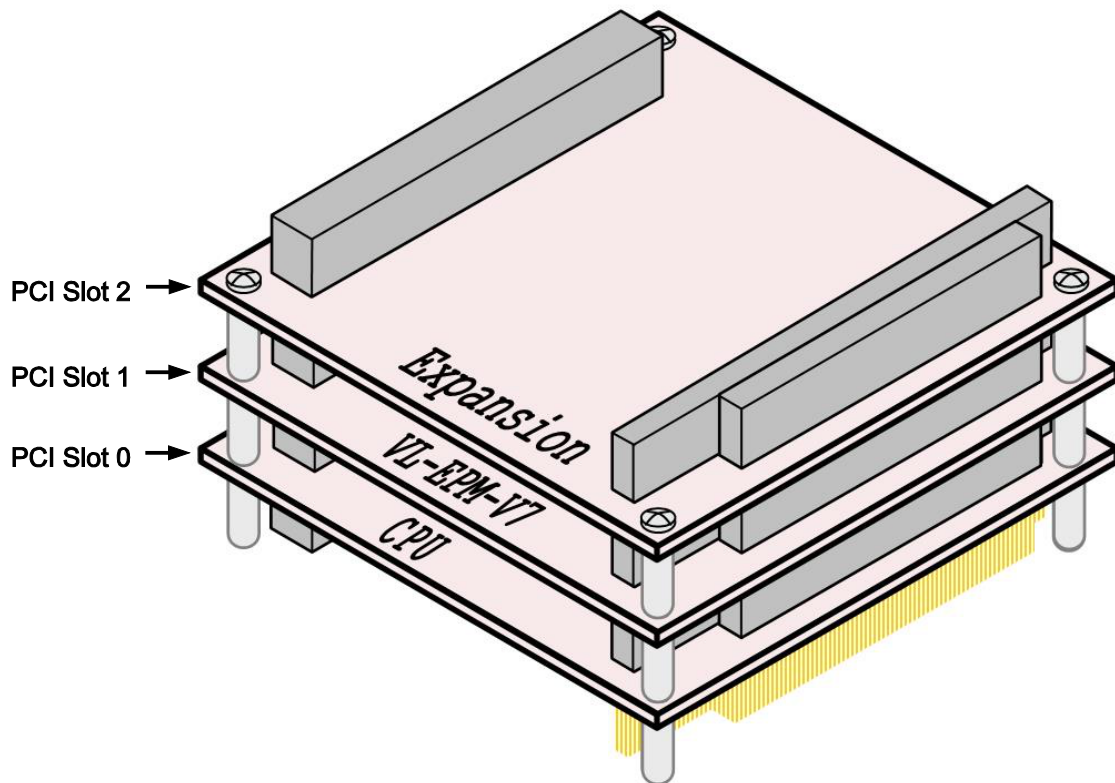

V7\_016

Figure 5. Stack Arrangement Example

# External Connectors

## CONNECTORS

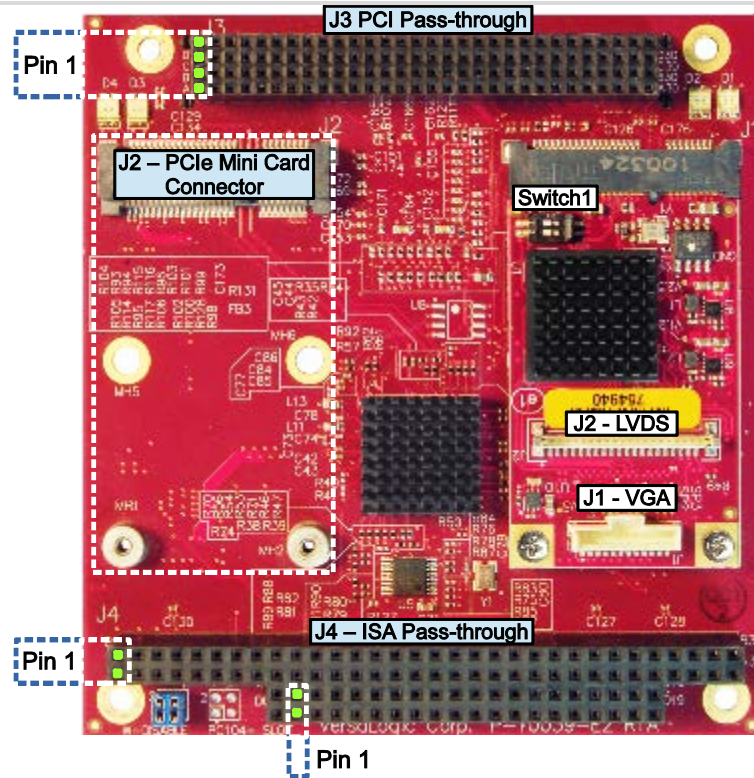

V7\_008

Figure 6. VL-EPM-V7 Connectors – Top Side

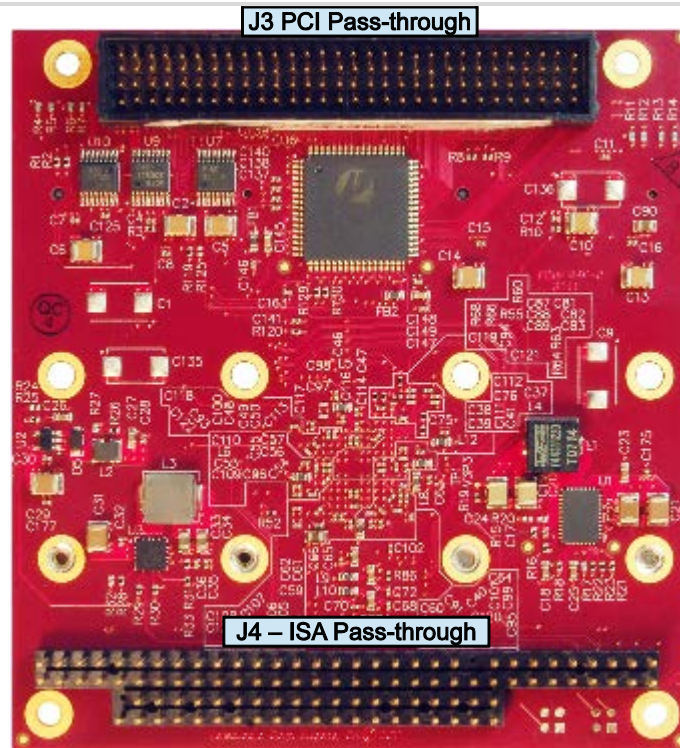

V7\_009

Figure 7. VL-EPM-V7 Connectors – Bottom Side

## CONNECTOR FUNCTIONS AND INTERFACE CABLES

Table 1 and Table 2 provide information about the function, mating connectors, and transition cables for VL-EPM-V7 connectors.

**Table 1: Baseboard Connector Functions and Interface Cables**

Connector	Function	Mating Connector	Reference
J1	PCIe Mini Video Card	—	Page 12
J2	PCIe Mini Card	—	Page 16
J3	PCI	AMP 1375799-1	—
J4	ISA Pass-through (VL-EPM-P2)	AMP 1375795-2	—

**Table 2: Video Mini Card Connector Functions and Interface Cables**

Connector	Function	Mating Connector	Transition Cable	Cable Description	Reference
J1	VGA	Molex 501330-0500 pin/crimp	VL-CBR-1204	12-inch VGA interface cable, 12-pin PicoClasp cable to 15-pin VGA	Page 12
J2	LVDS	Hirose DF19G-20S-1C (housing), Hirose DF19-2830SCFA x19 (crimp socket)	VL-CBR-2015 <b>(Note 1)</b> --or-- VL-CBR-2016 <b>(Note 2)</b>	20-inch 18- or 24-bit LVDS cable	Page 13

**Notes:**





1. Attaches to optional VL-CBR-2014, LVDS to VGA adapter.
2. The CBR-2015 works with the LVDS to VGA adapter; the CBR-2016 does not.



## JUMPER SUMMARY

Table 3 describes the PCI slot assignment settings resulting from the configuration of the V2 jumper block. Figure 8 shows the location of the V2 jumper block.

Table 3: V2 Jumper Block Configuration Summary

To configure the EPM-V7 for...	Set the jumpers this way...
PCI Slot 0	
PCI Slot 1	
PCI Slot 2	
PCI Slot 3	

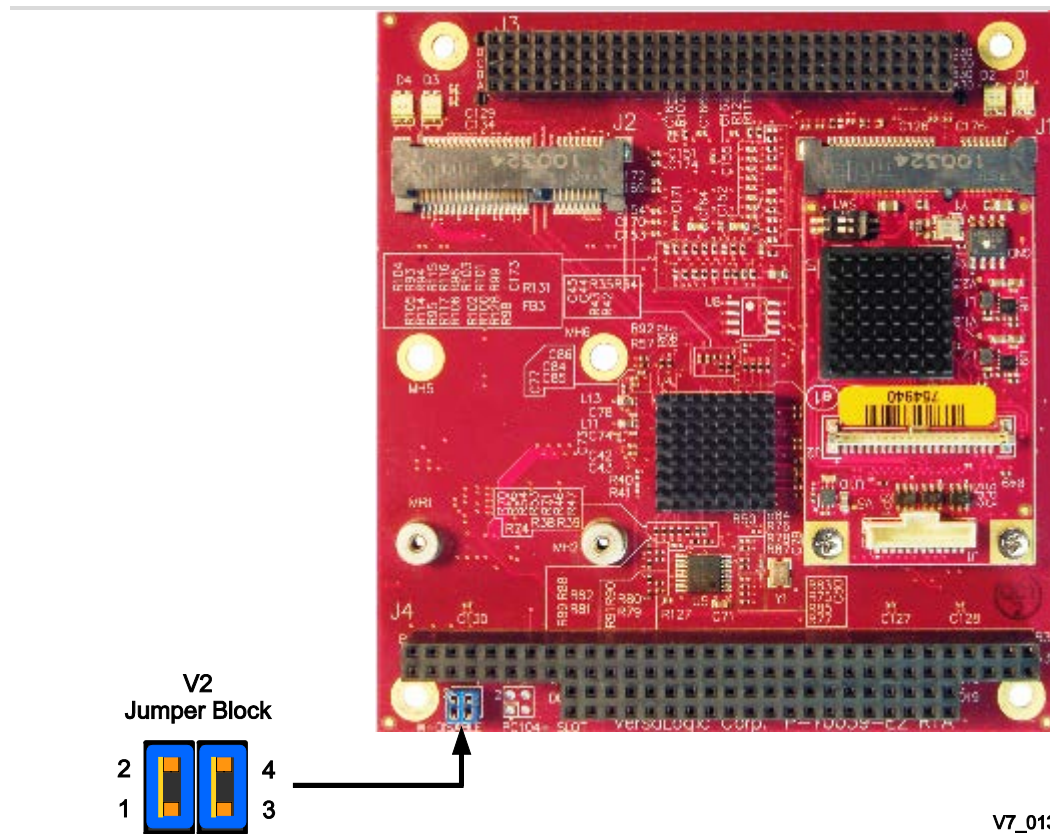

Figure 8. Location of V2 Jumper Block



# Interfaces and Connectors

## Video

The Silicon Motion SM750 graphics controller has integrated high-performance 2D video, analog and flat panel output capability, and 16 MB of embedded VRAM.

The controller supports a single display, two cloned displays, or two simultaneous independent displays. Table 4 lists the maximum resolutions for each video channel depending on the setup.

**Table 4: Maximum Display Resolutions**

Bits Per Pixel	Channels	Maximum CRT Resolution	Maximum LCD Resolution
16 bpp	Single	1920 x 1080	1280 x 1024
	Cloned	1280 x 1024	1280 x 1024
	Dual	1280 x 1024	1280 x 1024
32 bpp	Single	1440 x 960	1280 x 1024
	Cloned	1280 x 1024	1280 x 1024
	Dual	1280 x 720	800 x 600

## VGA INTERFACE

The VGA interface is a standard analog output with a 12-pin PicoClasp connector. An optional cable, part number VL-CBR-1204, is available to translate VGA connector J1 (on the video mini card) into a standard 15-pin D-Sub SVGA connector.

Table 5 lists the function of each pin.

**Table 5: J1 VGA Connector Pinout**

J1 Pin	Signal Name	Function	DB15 Pin
1	GND	Ground	6
2	VGA_RED	Red Video	1
3	GND	Ground	7
4	VGA_GREEN	Green Video	2
5	GND	Ground	8
6	VGA_BLUE	Blue Video	3
7	GND	Ground	5
8	VGA_HSYNC	Horizontal Sync	13
9	GND	Ground	10
10	VGA_VSYNC	Vertical Sync	14
11	CLK_VGA_DDC	DDC Serial Data Line Clock	15
12	VGA_DDC_DATA	DDC Serial Data Line	12

### LVDS FLAT PANEL DISPLAY CONNECTOR

The LVDS connector at location J2 (on the video mini card) is a 20-pin vertical Hirose-style connector.

The flat panel interface can support 18 or 24 bits of RGB pixel data plus three bits of timing control (HSYNC/VSYNC/DE) on the four differential data output pairs. The LVDS interface supports a maximum resolution of 1280 x 1024.

**Table 6: LVDS Flat Panel Display Pinout**

J2 Pin	Signal Name	Function
1	GND	Ground
2	NC	Not Connected
3	LVDSA3	Differential Data 3 (+)
4	LVDSA3#	Differential Data 3 (-)
5	GND	Ground
6	LVDSCLK0	Differential Clock (+)
7	LVDSCLK0#	Differential Clock (-)
8	GND	Ground
9	LVDSA2	Differential Data 2 (+)
10	LVDSA2#	Differential Data 2 (-)
11	GND	Ground
12	LVDSA1	Differential Data 1 (+)
13	LVDSA1#	Differential Data 1 (-)
14	GND	Ground
15	LVDSA0	Differential Data 0 (+)
16	LVDSA0#	Differential Data 0 (-)
17	GND	Ground
18	GND	Ground
19	+3.3V	+3.3V (Protected)
20	+3.3V	+3.3V (Protected)

The +3.3V power provided to pins 19 and 20 of J2 is protected by a software-controllable power switch (1 A, maximum.). This switch is controlled by the FP\_VDDEN signal from the flat panel interface in the video controller.

## LVDS TO VGA ADAPTER

A VGA monitor can be attached to the J2 connector (on the video mini card) using the VL-CBR-2014 LVDS to VGA adapter card. Use the following procedure to do this.

1. Plug the "Host End" of the LVDS cable VL-CBR-2015 into connector J2 of the video mini card on the VL-EPM-V7.
2. Plug the LVDS cable into connector J1 of the VL-CBR-2014 adapter card as shown in Figure 9.
3. Attach the VGA monitor data cable to connector CN1 of the VL-CBR-2014 adapter cable.

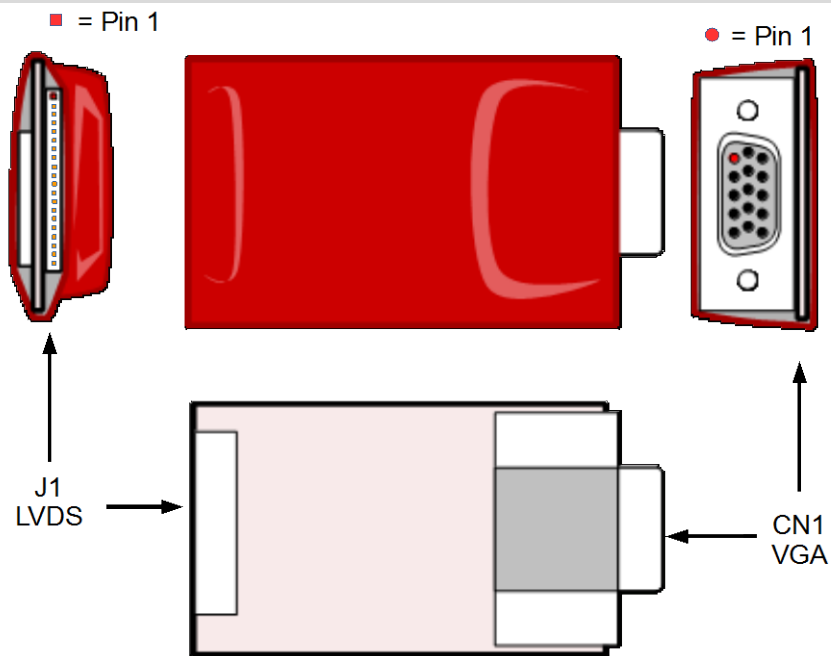

Figure 9. VL-CBR-2014 LVDS to VGA Adapter Card

### LVDS Resolution Switch

The two switches at location SW1 provide several startup options for standard LVDS flat panel types. If these options do not match the requirements of the panel you are using, contact [Support@VersaLogic.com](mailto:Support@VersaLogic.com) for a custom video BIOS. Table 7 lists the available startup resolutions.

**Table 7: LVDS Startup Resolution Switch Settings**

Switch 1	Switch 2	Resolution
Off	Off	640 x 480 (default)
On	Off	800 x 600
Off	On	1024 x 768
On	On	1280 x 1024

Figure 10 shows the location of the switches as well as their Off/On positions.

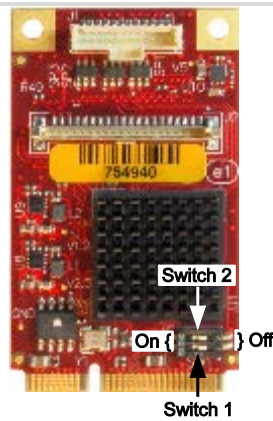

V7\_012

**Figure 10. LVDS Resolution Switch Positions**

## PCI Express Mini Card Socket

The PCI Express Mini Card connector at J2 accepts a full-height PCI Express Mini Card. The interface includes one PCIe x1 lane. The socket is compatible with 802.11a/b/g Wi-Fi network adapters that operate in both the 2.4 and 5.0 GHz spectra, GPS radio cards that enable time/date stamps and global location applications, 3G modems, and solid-state drives (SSDs).

**Table 8: PCIe Mini Card Pinout**

Pin	Signal Name	Function	Pin	Signal Name	Function
1	WAKE#	Wake	2	3.3VAUX	3.3V auxiliary source
3	NC	Not connected	4	GND	Ground
5	NC	Not connected	6	1.5V	1.5V power
7	CLKREQ#	Reference clock request	8	NC	Not connected
9	GND	Ground	10	NC	Not connected
11	REFCLK-	Reference clock input –	12	NC	Not connected
13	REFCLK+	Reference clock input +	14	NC	Not connected
15	GND	Ground	16	NC	Not connected
17	NC	Not connected	18	GND	Ground
19	NC	Not connected	20	W_DISABLE#	Wireless disable
21	GND	Ground	22	PERST#	Card reset
23	PERn0	Lane 0 receive –	24	3.3VAUX	3.3V auxiliary source
25	PERp0	Lane 0 receive +	26	GND	Ground
27	GND	Ground	28	1.5V	1.5V power
29	GND	Ground	30	NC	Not connected
31	PETn0	PCIe lane 0 transmit –	32	NC	Not connected
33	PETp0	PCIe lane 0 transmit +	34	GND	Ground
35	GND	Ground	36	NC	Not connected
37	GND	Ground	38	NC	Not connected
39	3.3VAUX	3.3V auxiliary source	40	GND	Ground
41	3.3VAUX	3.3V auxiliary source	42	LED_WWAN#	Wireless WAN LED
43	GND	Ground	44	LED_WLAN#	Wireless LAN LED
45	NC	Not connected	46	LED_WPAN#	Wireless PAN LED
47	NC	Not connected	48	1.5V	1.5V power
49	NC	Not connected	50	GND	Ground
51	NC	Not connected	52	3.3VAUX	3.3V auxiliary source

To secure a Mini Card to the module, use two screws (M2.5 x 6 mm, Philips, pan head, 4 mm, stainless) and two washers (M2.5, split lock, OD 4.4 mm, stainless). Nylon screws are available in 10-count packages as part number VL-HDW-108.

### LED\_WWAN#, LED\_WLAN#, AND LED\_WPAN# SIGNALS

The LED status indicator signals enable wireless communications add-in cards to provide status via the LEDs at positions D3 and D4 on the module. The behavior of the LEDs is determined by the add-in card manufacturer. Table 9 shows the routing of the D3 and D4 LEDs to the Mini Card LED status signals. Figure 11 shows the location of the D3 and D4 LEDs.

**Table 9: Wi-Fi Mini Card LED Functions**

LED	Color	J2 Pin	Function
D3	Green	–	Power status indicator
D3	Yellow	42	Defined by Mini Card device LED_WWAN# implementation
D4	Green	44	Defined by Mini Card device LED_WLAN# implementation
D4	Yellow	46	Defined by Mini Card device LED_WPAN# implementation

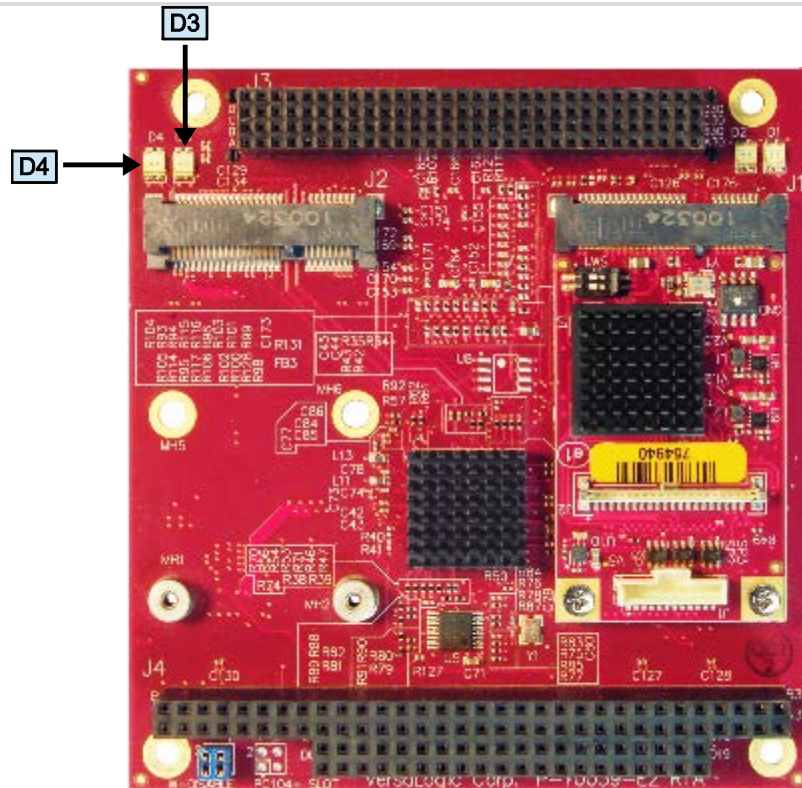

V7\_014

**Figure 11. Location of D3 and D4 LEDs**

# Appendix A – References

---



PC/104 Interface

[PC/104 Specification](#)

PC/104-*Plus* Interface

[PC/104-Plus Specification](#)



# Appendix B – Technical Notes

## Drivers

Linux and Windows drivers for the video module are available for download on the [VL-EPM-V7 Product Support Page](#).

## BIOS Configuration

The VL-EPM-V7 can be installed on CPU boards with no graphics controller or with an on-board graphics controller (either in a separate chip or integrated into the processor). In cases where an on-board graphics controller is to be used at the same time as the VL-EPM-V7, it is typically necessary to configure the BIOS of the CPU board so that it recognizes the on-board controller as the primary graphics device. This is because when the CPU board detects the presence of an add-on graphics controller, the on-board controller is usually not fully initialized. Identifying the on-board device as the primary graphics controller resolves this issue.

See the BIOS or CMOS Setup Reference article in the [VersaTech KnowledgeBase](#) for your CPU board to determine how to configure the primary graphics controller in the BIOS, or contact [VersaLogic Customer Support](#).