

# SPECIFICATIONS

"Preliminary data"



**Model Number:** CR3512MB-G50  
**Part Number:** 17000200A

**Version:** Apr 11, 2017

## Mechanical Drawing:

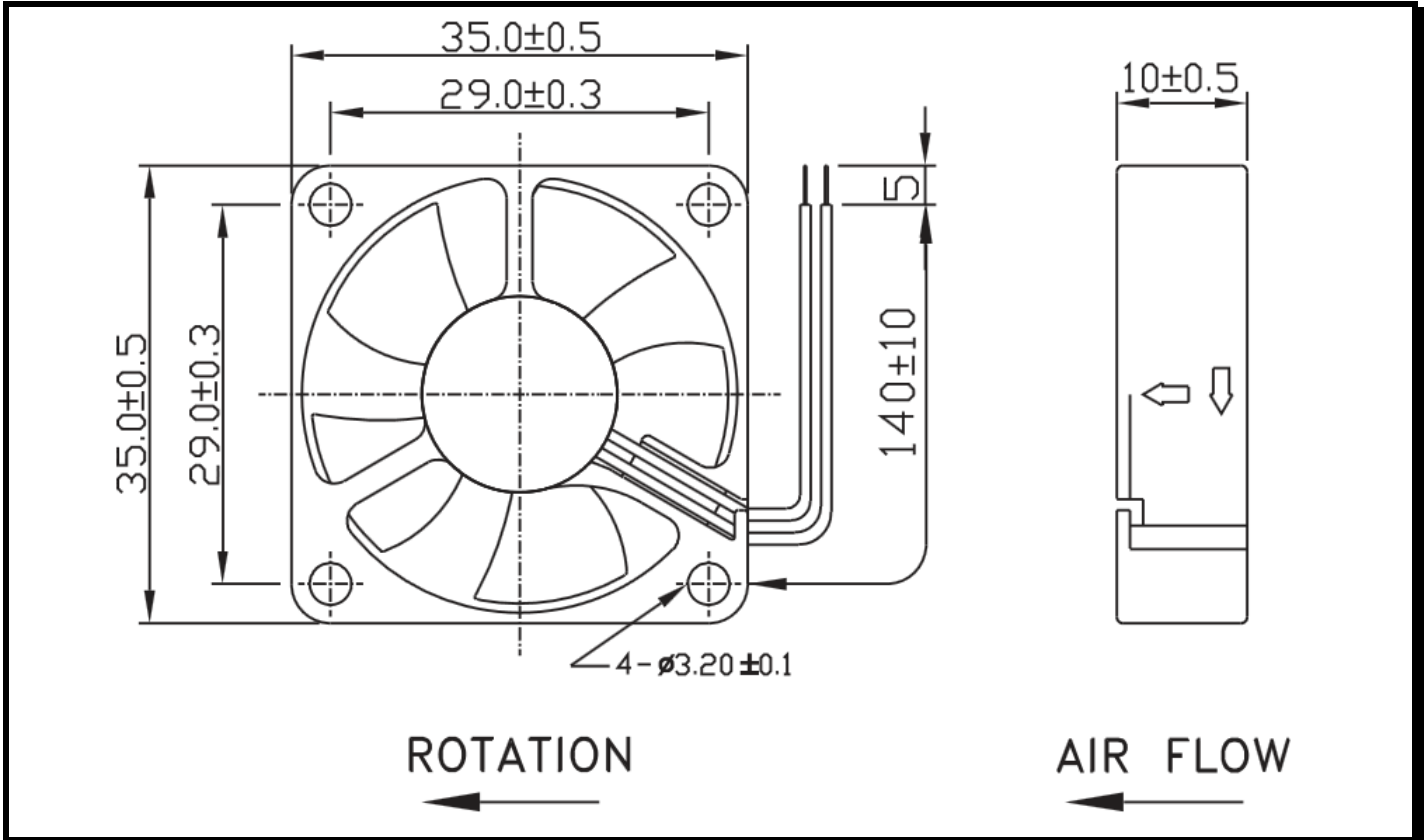

### Motor:

Nominal Voltage	= 12 VDC
Nominal Running Current	= 0.06 Amps
Power Input	= 0.66 Watts
Speed	= 8000 RPM
Bearings	= Ball
Air Flow	= 6.0 CFM
Static Pressure:	= 0.17 Inch of H <sub>2</sub> O
Acoustic	= 32.0 dB(A)
Weight	= 9.0 g

### Construction:

Housing: UL94V-0 Glass Filled Polyester (P.B.T)  
Impeller: UL94V-0 Glass Filled Polyester (P.B.T)

### Life Expectancy:

This fan is designed for continuous duty life of 70,000 hours at 40°C.

### Additional Features:

Brushless DC Motor  
Locked Rotor Protection  
Polarity Protected  
Automatic Restart Capability  
Operating Temperature: -10° C to 70° C  
Storage Temperature: -40° C to 70° C

### Termination:

140 ± 10 mm Lead wires, AWG 28, UL 1571

### Agency Approvals:

UL, CUL, TUV, CE