

COMPACT SHIELDED SMD POWER INDUCTOR FOR AUTOMOTIVE

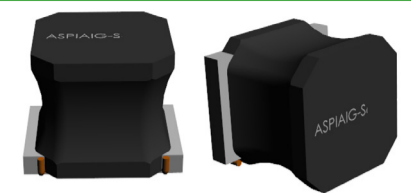

ASPIAIG-SXXXX SERIES

ASPIAIG-S6055: 6.0 x 6.0 x 5.5 mm
ASPIAIG-S8050: 8.0 x 8.0 x 5.0 mm

RoHS/RoHS II Compliant

MSL = 1

FEATURES

- High reliability wire-wound construction
- Shielded construction reduces EMI
- Automotive grade power inductor
- TS-16949 qualified production
- PPAP level 3 support
- AEC-Q200 qualified with -40°C to 125°C operation
- High inductance up to 470µH

APPLICATIONS

- Height restricted applications
- Automotive body electronics and comfort system
- Automotive infotainment and entertainment
- Automotive navigation
- Transportation
- Lighting, LED ballasts
- Industrial Internet of Things (IIoT)
- Industrial applications
- Solar power
- DC/DC converters and switch mode power supplies

STANDARD SPECIFICATIONS

Operating Temperature	-40°C ~ +125°C
Storage Condition	-10°C ~ +40°C and R.H. 70% max

Part Number	Inductance	Tolerance	Self-resonant	DC Resistance	Saturation Current	Temperature Rise Current
	100kHz/1V		Min	Max Max (25°C)	Typ	Typ
Units	µH	%	MHz	Ω	A	A
Symbol	L	M	SRF	DCR	Isat	Irms
ASPIAIG-S6055-3R3	3.3	20	32	0.026	6.00	4.60
ASPIAIG-S6055-4R7	4.7	20	24	0.031	5.00	4.25
ASPIAIG-S6055-6R8	6.8	20	20	0.034	4.30	4.10
ASPIAIG-S6055-8R2	8.2	20	21	0.049	4.30	3.40
ASPIAIG-S6055-100	10	20	15	0.054	3.70	3.20
ASPIAIG-S6055-150	15	20	12	0.074	3.30	2.75
ASPIAIG-S6055-220	22	20	10	0.100	2.60	2.35
ASPIAIG-S6055-330	33	20	7.8	0.170	2.00	1.80
ASPIAIG-S6055-470	47	20	6.4	0.252	1.70	1.50
ASPIAIG-S6055-680	68	20	6.4	0.353	1.40	1.25
ASPIAIG-S6055-101	100	20	4.2	0.434	1.10	1.10
ASPIAIG-S6055-151	150	20	4.2	0.686	0.90	0.90
ASPIAIG-S6055-221	220	20	3.5	1.036	0.70	0.70
ASPIAIG-S6055-331	330	20	2.8	1.603	0.65	0.60
ASPIAIG-S8050-1R0	1.0	20	99	0.010	16.00	7.20
ASPIAIG-S8050-1R5	1.5	20	79	0.012	13.00	6.50
ASPIAIG-S8050-2R2	2.2	20	59	0.014	11.00	5.80
ASPIAIG-S8050-3R3	3.3	20	24	0.020	9.00	4.90
ASPIAIG-S8050-4R7	4.7	20	23	0.023	7.50	4.60
ASPIAIG-S8050-6R8	6.8	20	19	0.029	6.10	4.20
ASPIAIG-S8050-8R2	8.2	20	18	0.035	5.60	3.80
ASPIAIG-S8050-100	10	20	14	0.038	5.20	3.60
ASPIAIG-S8050-150	15	20	13	0.061	4.50	2.70
ASPIAIG-S8050-220	22	20	9.0	0.088	3.50	2.20
ASPIAIG-S8050-330	33	20	7.6	0.122	3.00	2.00
ASPIAIG-S8050-470	47	20	6.6	0.173	2.40	1.70
ASPIAIG-S8050-680	68	20	5.4	0.252	2.00	1.45
ASPIAIG-S8050-101	100	20	4.4	0.326	1.60	1.25
ASPIAIG-S8050-151	150	20	3.2	0.480	1.40	1.00
ASPIAIG-S8050-221	220	20	2.9	0.708	1.10	0.75
ASPIAIG-S8050-331	330	20	2.3	1.044	0.90	0.65
ASPIAIG-S8050-471	470	M	1.9	1.540	0.80	0.55

REVISED: 12.21.2016

COMPACT SHIELDED SMD POWER INDUCTOR FOR AUTOMOTIVE

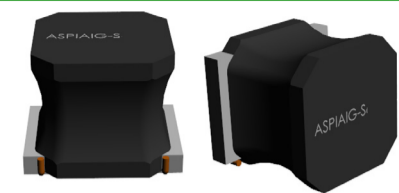

ASPIAIG-SXXXX SERIES

ASPIAIG-S6055: 6.0 x 6.0 x 5.5 mm
ASPIAIG-S8050: 8.0 x 8.0 x 5.0 mm

Pb RoHS/RoHS II Compliant

MSL = 1

PART NUMBER IDENTIFICATION

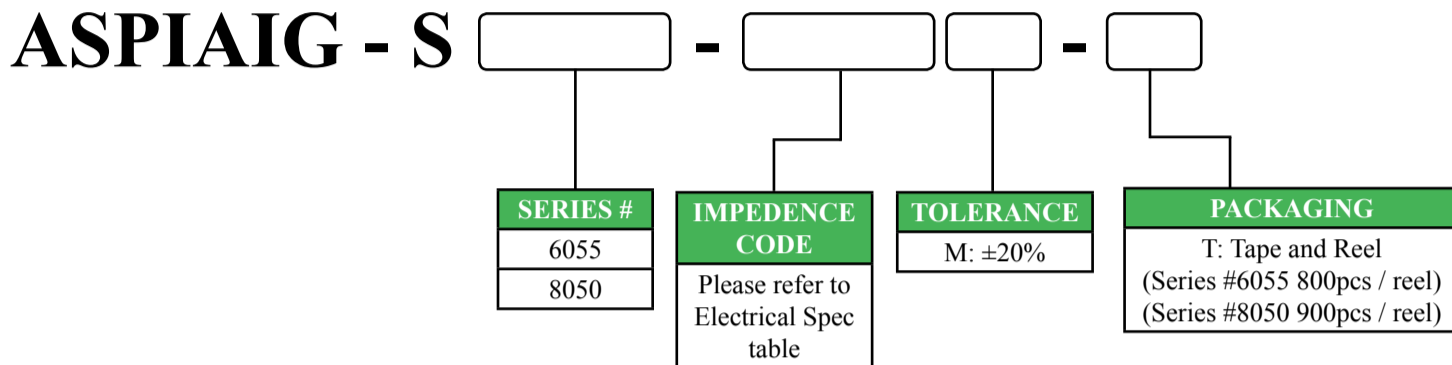

ELECTRICAL CHARACTERISTICS

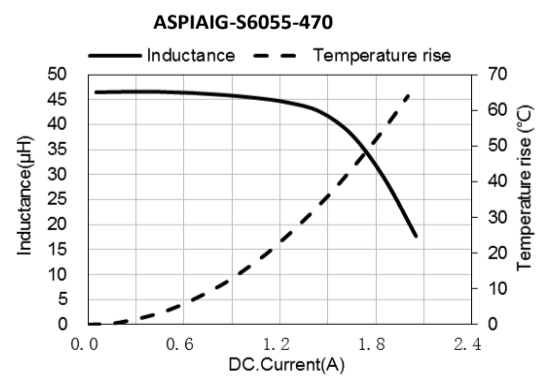
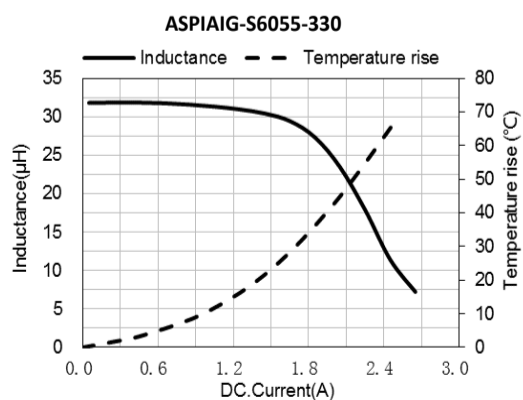
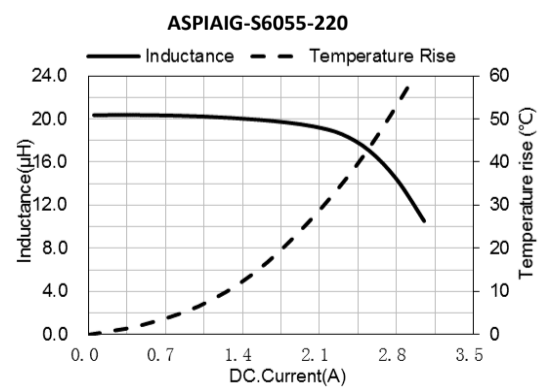
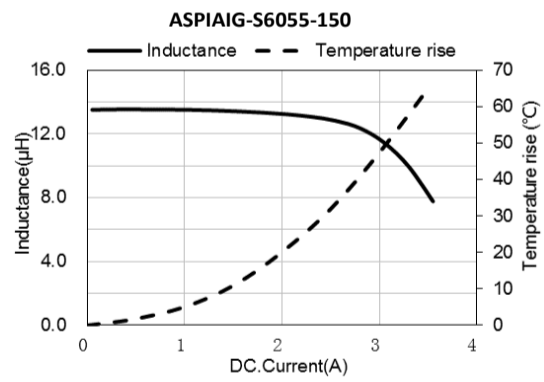
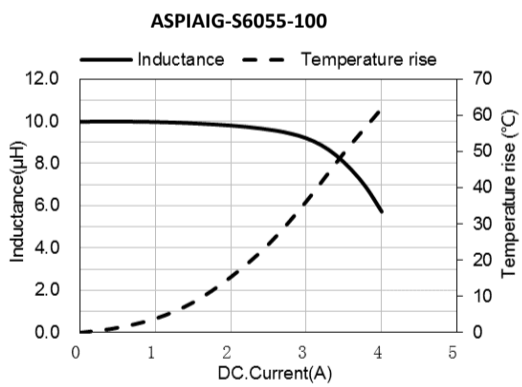
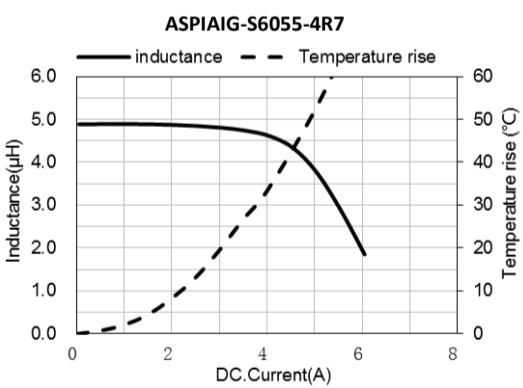
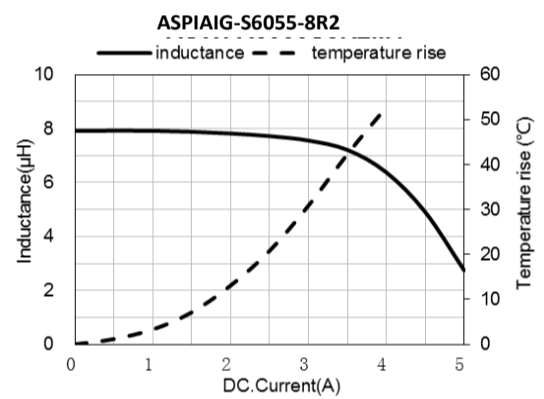
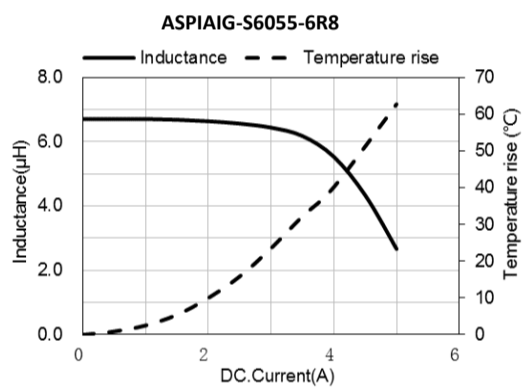
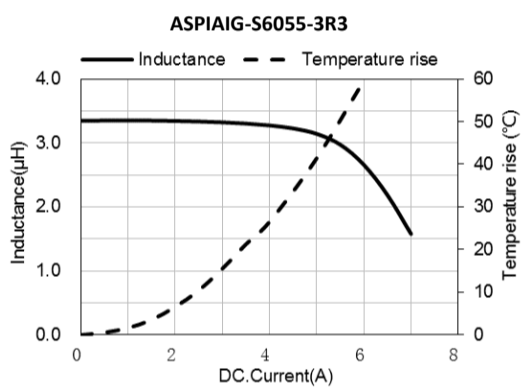

REVISED: 12.21.2016



5101 Hidden Creek Ln Spicewood TX 78669
Phone: 512-371-6159 | Fax: 512-351-8858
For terms and conditions of sales, please visit:
www.abracon.com

ABRACON IS
ISO9001-2008
CERTIFIED

COMPACT SHIELDED SMD POWER INDUCTOR FOR AUTOMOTIVE

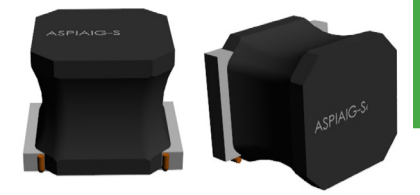

ASPIAIG-SXXXX SERIES

ASPIAIG-S6055: 6.0 x 6.0 x 5.5 mm
ASPIAIG-S8050: 8.0 x 8.0 x 5.0 mm

Pb RoHS/RoHS II Compliant

MSL = 1

ELECTRICAL CHARACTERISTICS

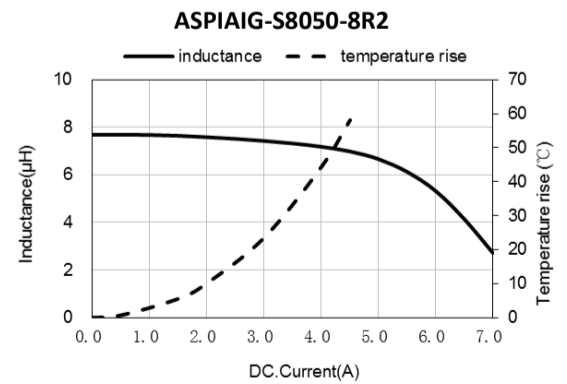
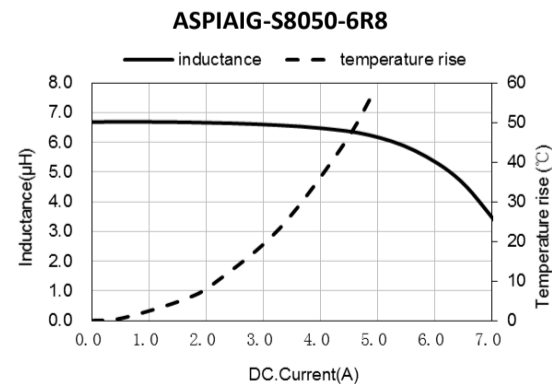
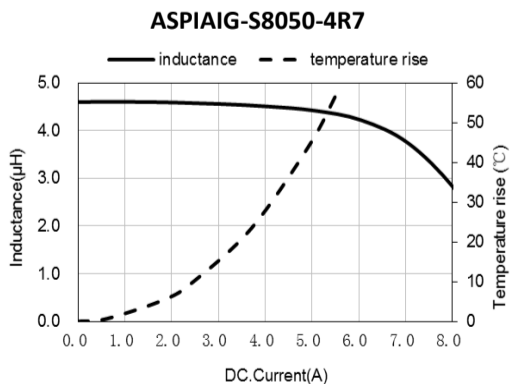
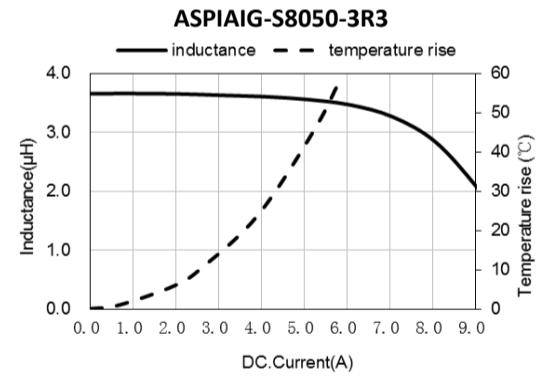
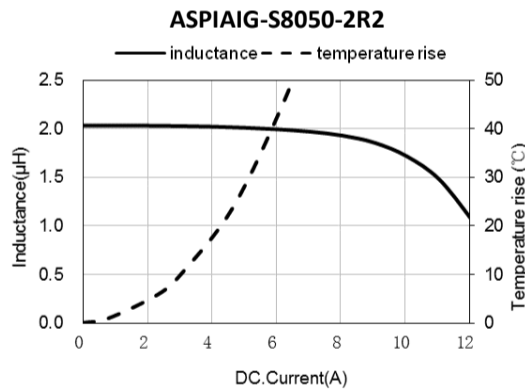
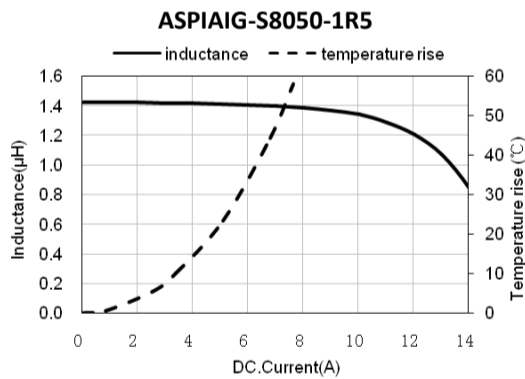
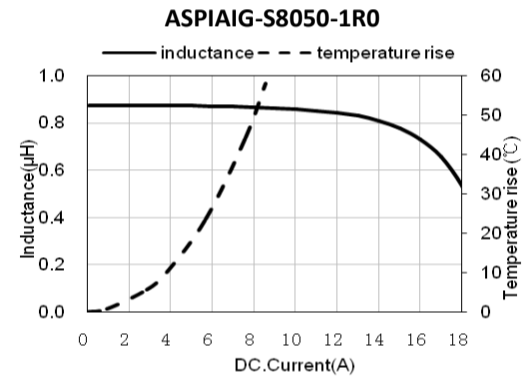
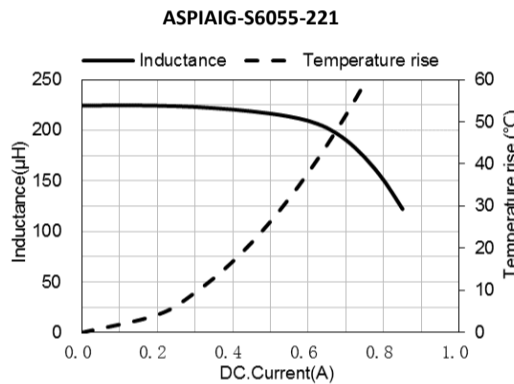
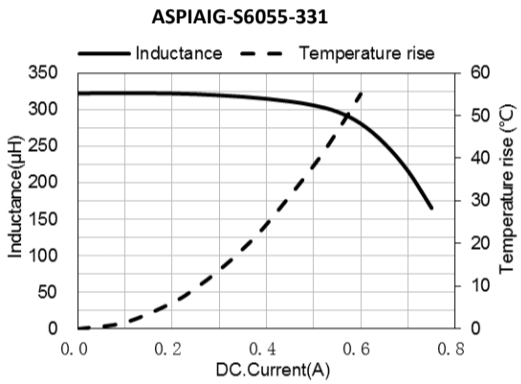
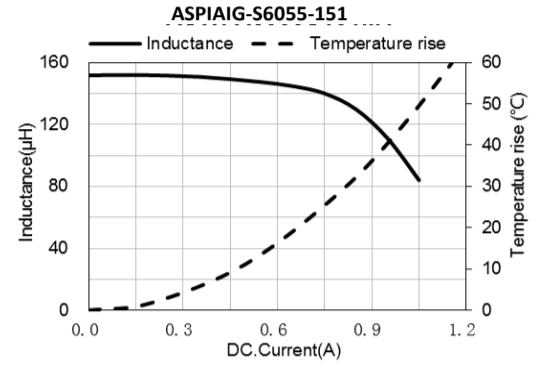
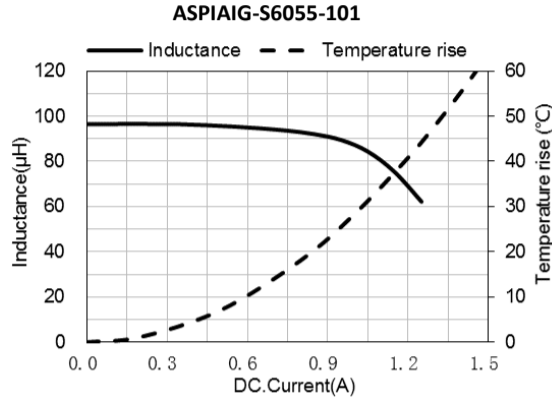
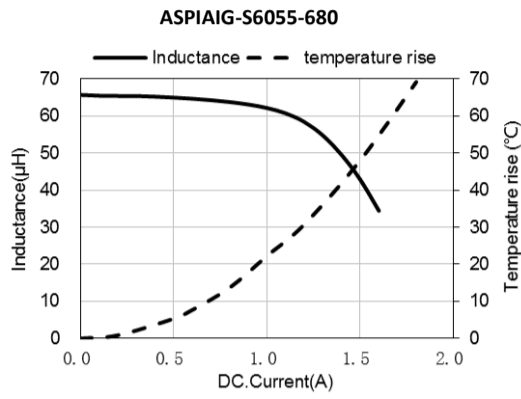

COMPACT SHIELDED SMD POWER INDUCTOR FOR AUTOMOTIVE

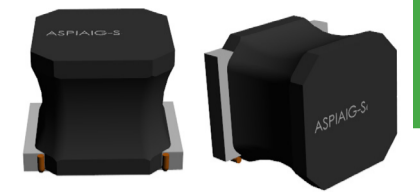

ASPIAIG-SXXXX SERIES

ASPIAIG-S6055: 6.0 x 6.0 x 5.5 mm
ASPIAIG-S8050: 8.0 x 8.0 x 5.0 mm

RoHS/RoHS II Compliant

MSL = 1

ELECTRICAL CHARACTERISTICS

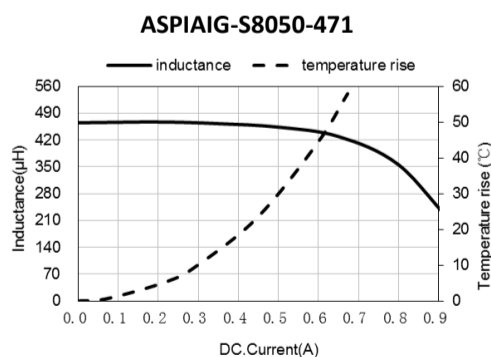
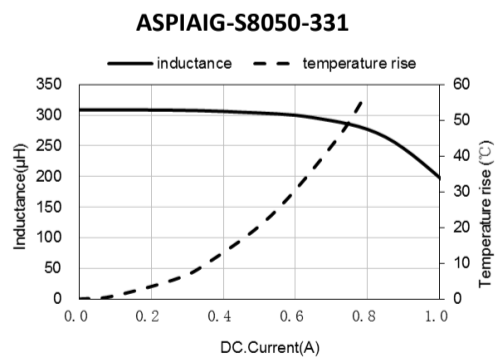
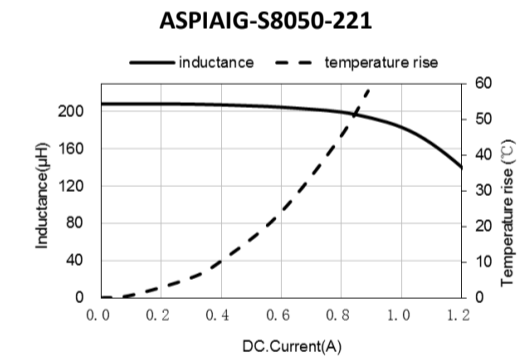
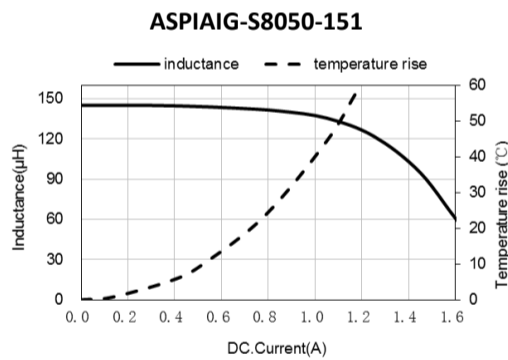
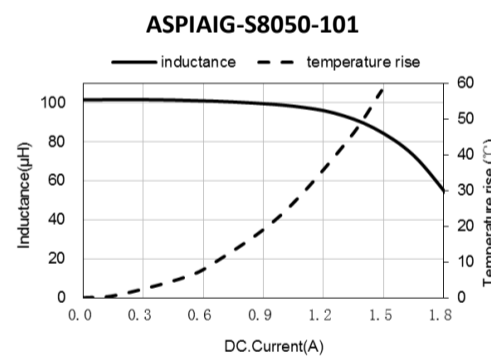
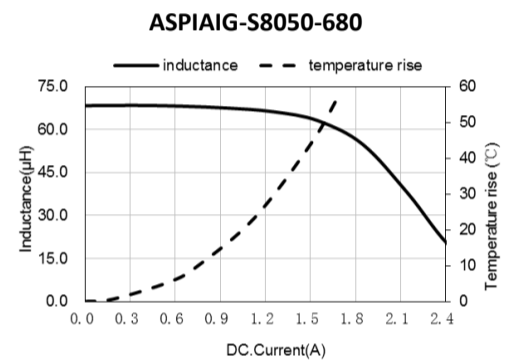
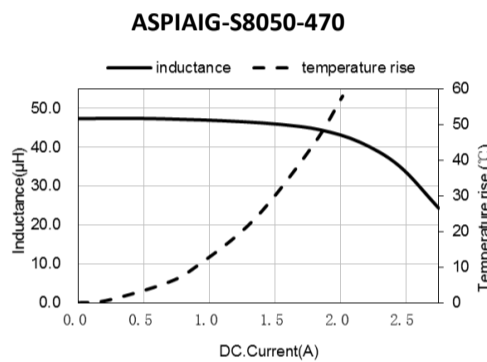
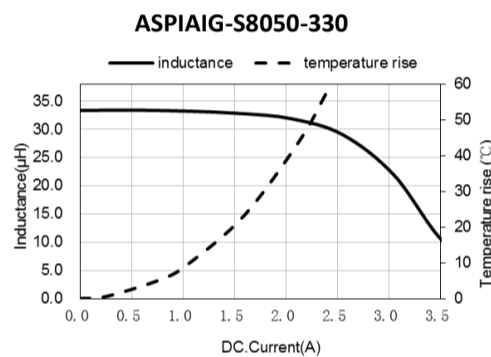
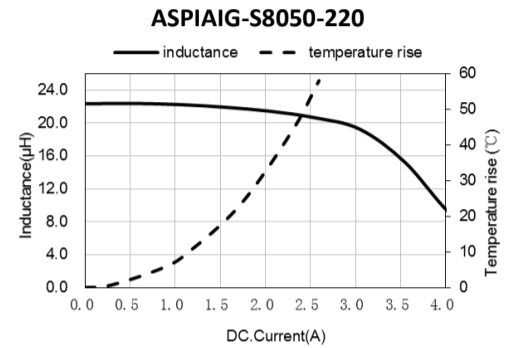
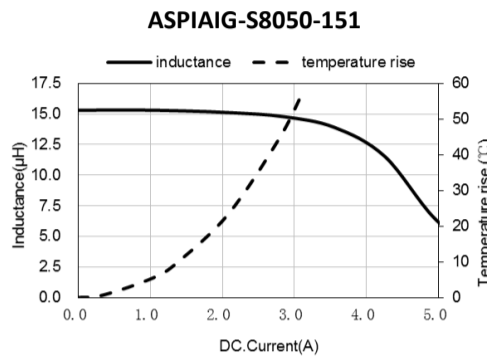
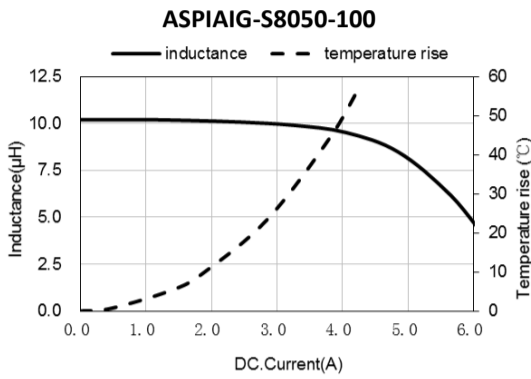

REVISED: 12.21.2016

COMPACT SHIELDED SMD POWER INDUCTOR FOR AUTOMOTIVE



ASPIAIG-SXXXX SERIES

ASPIAIG-S6055: 6.0 x 6.0 x 5.5 mm
ASPIAIG-S8050: 8.0 x 8.0 x 5.0 mm

RoHS/RoHS II Compliant

MSL = 1

MECHANICAL DIMENSIONS

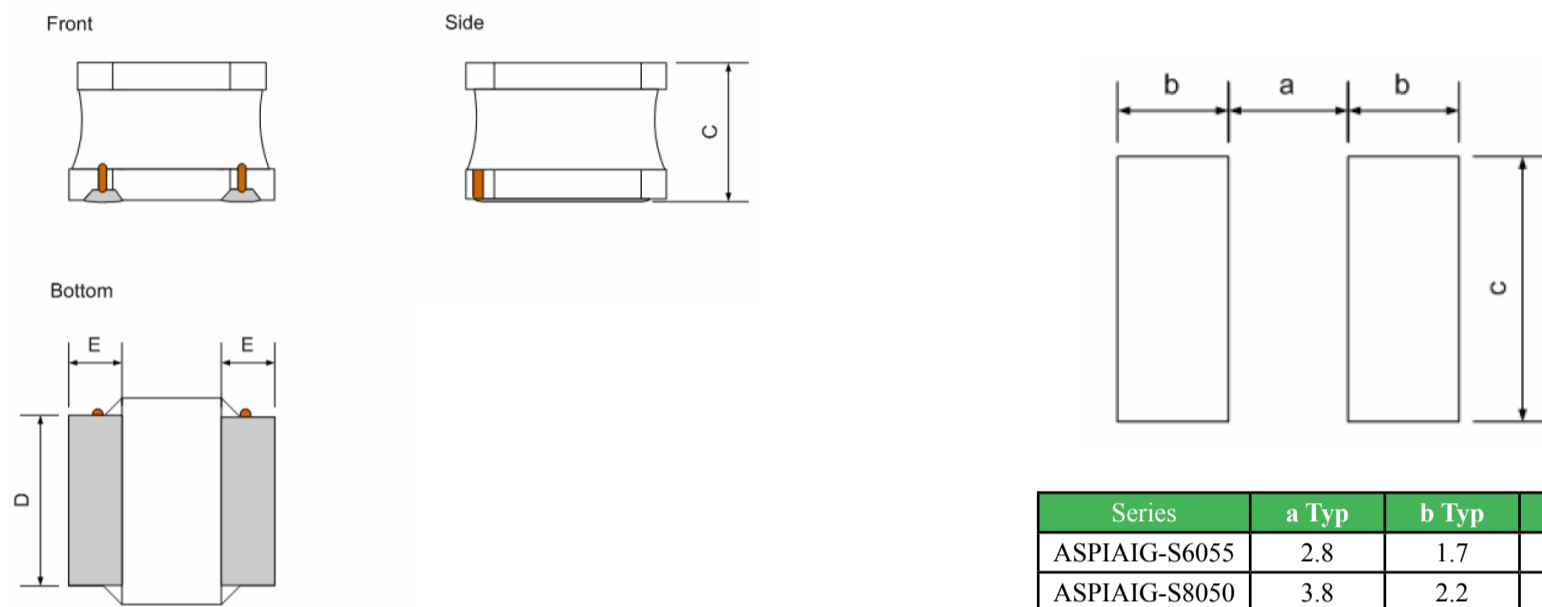

Series	A	B	C	D	E
ASPIAIG-S6055	6.0 ± 0.2	6.0 ± 0.2	5.5 ± 0.2	4.9 ± 0.2	1.55 ± 0.3
ASPIAIG-S8050	8.0 ± 0.3	8.0 ± 0.3	5.0 ± 0.2	6.3 ± 0.3	2.0 ± 0.2

REFLOW PROFILE

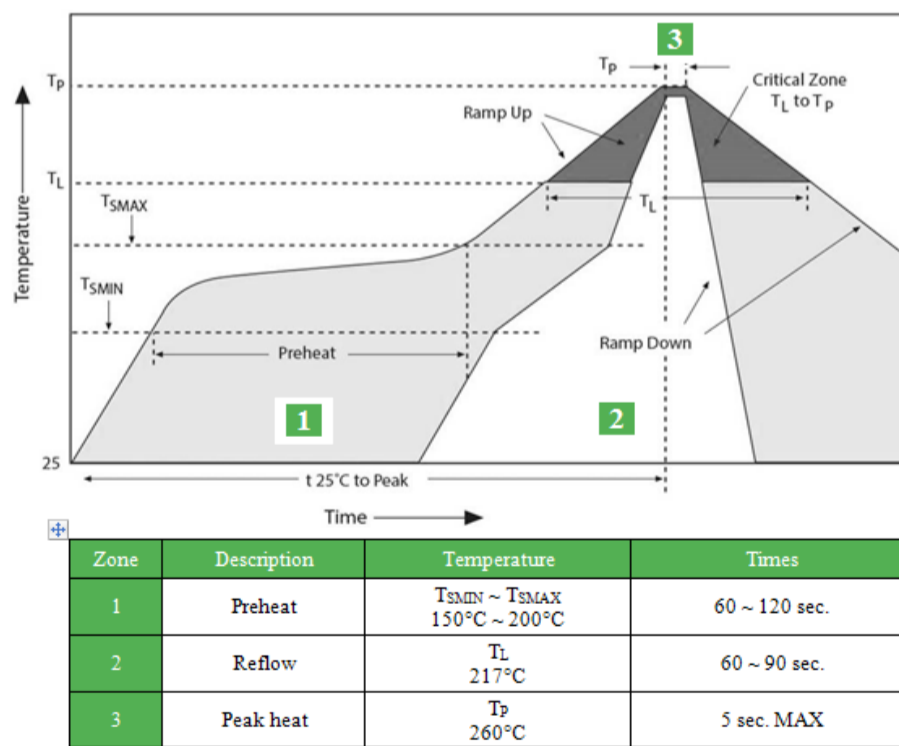

COMPACT SHIELDED SMD POWER INDUCTOR FOR AUTOMOTIVE

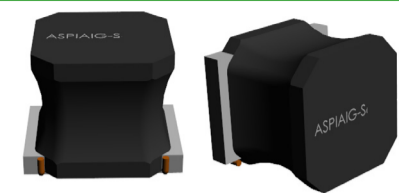

ASPIAIG-SXXXX SERIES

ASPIAIG-S6055: 6.0 x 6.0 x 5.5 mm
ASPIAIG-S8050: 8.0 x 8.0 x 5.0 mm

RoHS/RoHS II Compliant

MSL = 1

PACKAGING

TAPE AND REEL: 800 PCS/REEL (S6055)

TAPE AND REEL: 900 PCS/REEL (S8050)

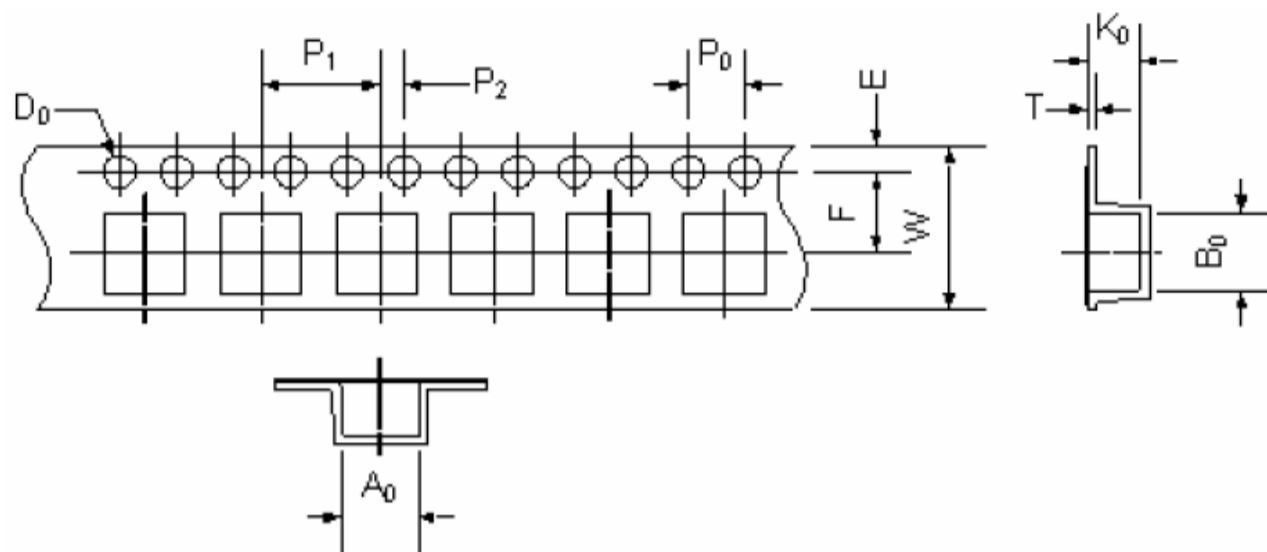

SERIES#	W	E	F	P0	P1	P2	D0	A0	B0	T	K0
ASPIAIG-S6055	16.0±0.3	1.75±0.1	7.5±0.1	4.0±0.1	8.0±0.1	2.0±0.1	1.5+0.1/-0.0	6.3±0.1	6.3±0.1	0.50±0.05	5.7±0.1
ASPIAIG-S8050	16.0±0.3	1.75±0.1	7.5±0.1	4.0±0.1	12.0±0.1	2.0±0.1	1.5+0.1/-0.0	8.3±0.1	8.3±0.1	0.50±0.05	5.2±0.1

PACKAGING: DIRECTION OF ROLLING

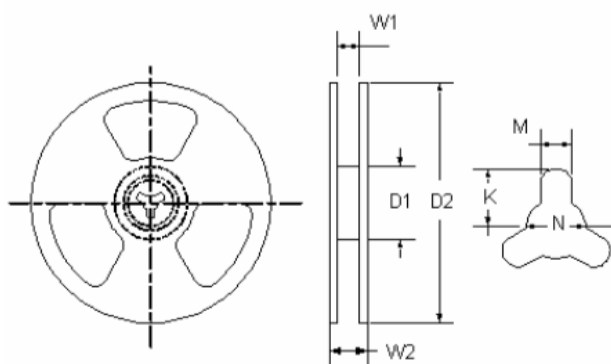
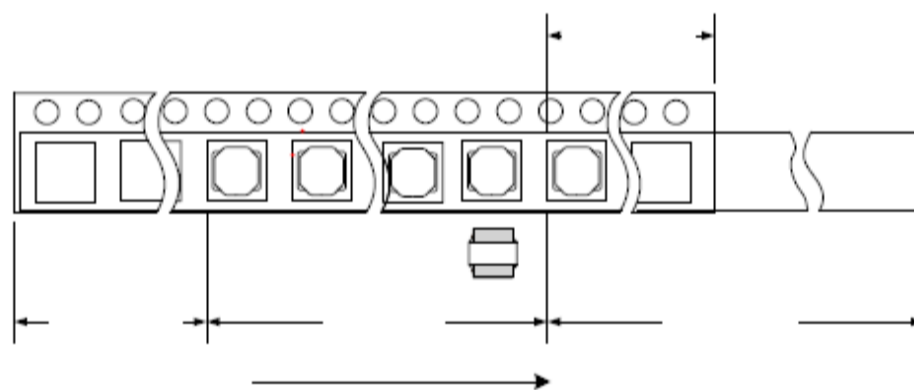

D1	100 ± 0.5
D2	330 ± 0.1
W1	16.4 +0.2 / -0.0
W2	22.4 MAX
K	10.75 ± 0.2
M	2.3 ± 0.2
N	13.0 +0.2 / -0.0

COMPACT SHIELDED SMD POWER INDUCTOR FOR AUTOMOTIVE

ASPIAIG-SXXXX SERIES

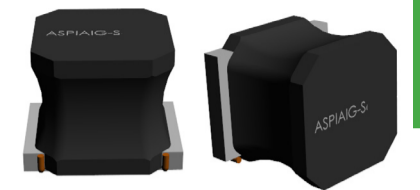

ASPIAIG-S6055: 6.0 x 6.0 x 5.5 mm
ASPIAIG-S8050: 8.0 x 8.0 x 5.0 mm

 RoHS/RoHS II Compliant

MSL = 1

NOTES

1. The parts are manufactured in accordance with this specification. If other conditions and specifications which are required for this specification, please contact ABRACON for more information.
2. ABRACON will supply the parts in accordance with this specification unless we receive a written request to modify prior to an order placement.
3. In no case shall ABRACON be liable for any product failure from in appropriate handling or operation of the item beyond the scope of this specification.
4. When changing your production process, please notify ABRACON immediately.
5. ABRACON LLC's products are COTS – Commercial-Off-The-Shelf products; suitable for Commercial, Industrial and, where designated, Automotive Applications. ABRACON's products are not specifically designed for Military, Aviation, Aerospace, Life-dependant Medical applications or any application requiring high reliability where component failure could result in loss of life and/or property. For applications requiring high reliability and/or presenting an extreme operating environment, written consent and authorization from ABRACON Corporation is required. Please contact ABRACON Corporation for more information.
6. All specifications and Marking will be subject to change without notice.