

SERVICE

If the instrument fails to operate, check battery, test leads, etc. and replace as necessary. If the instrument still does not operate, double check operating procedure as described in the instruction manual. If the instrument still malfunctions, place it with packing slip along with a brief description of the problem in sufficient cushioning material in a shipping carton. Be sure to indicate the serial number located on the back of the instrument. Amprobe is not responsible for damage in transit. Make certain your name and address also appears on the box as well as packing slip: Ship prepaid via U.P.S. (where available) or Air Parcel Post insured to:

Service Division
AMPROBE INSTRUMENT
630 Merrick Road (use for U.P.S.)
P.O. Box 329 (use for Parcel Post)
Lynbrook, NY 11563-0329

Outside the U.S.A. the local Amprobe representative will assist you.

AMPROBE INSTRUMENT®
DIVISION OF CORE INDUSTRIES INC
630 Merrick Rd., P.O. Box 329, Lynbrook, NY 11563
(516) 593-5600 • (516) 593-5682

P/N 978752

- 40 -

Manual P/N: 978752
5/96

USER MANUAL

A UNIQUE CLAMP-ON MULTIMETER

MODEL: ACDC-3000

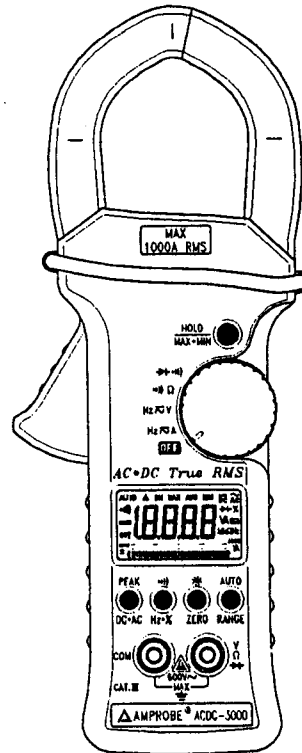

AMPROBE INSTRUMENT®
DIVISION OF CORE INDUSTRIES INC
630 Merrick Rd., P.O. Box 329, Lynbrook, NY 11563
(516) 593-5600 • (516) 593-5682

Limited Warranty

Congratulations! You are now the owner of an AMPROBE Instrument. It has been crafted according to the highest standards of quality and workmanship. This instrument has been inspected for proper operation of all of its functions. It has been tested by qualified factory technicians according to the long established standards of AMPROBE INSTRUMENT.

Your AMPROBE Instrument has a limited warranty against defective materials, and/or workmanship for one year from the date of purchase provided the seal is unbroken or, in the opinion of the factory, the instrument has not been opened, tampered with, or taken apart.

Should your instrument fall due to defective materials and/or workmanship during the one-year warranty period, return it along with a copy of your dated bill-of-sale which must identify the instrument by model number and serial number.

IMPORTANT: For your protection, please use the instrument as soon as possible. If damaged, or should the need arise to return your instrument, place it in a shipping carton packed with sufficient cushioning material. It must be securely wrapped. Amprobe is not responsible for damage in transit. Be sure to include a packing slip (indicating model and serial number) along with a brief description of the problem. Make certain your name and address appears on the box as well as packing slip.

Ship prepaid via Air Parcel Post insured or U.P.S. (where available) to:

Service Division
AMPROBE INSTRUMENT
630 Merrick Road (use for U.P.S.)
P.O. Box 329 (use for Parcel Post)
Lynbrook, NY 11563-0329

Outside the U.S.A. the local Amprobe representative will assist you. Above limited warranty covers repair and replacement of instrument only and no other obligation is stated or implied.

**ACDC-3000
TABLE OF CONTENTS**

	PAGE
LIMITED WARRANTY	1
SAFETY INFORMATION	4
A UNIQUE CLAMP-ON MULTIMETER	5
• INTRODUCTION TO THE ACDC-3000	5
USING THE METER SAFELY	7
LCD DISPLAY ILLUSTRATION	8
GETTING ACQUAINTED WITH YOUR METER	9
• ALIGNMENT MARKS	9
• ROTARY SWITCH	9
• INPUT TERMINAL	10
• PUSH BUTTONS	11
PUSH-BUTTON OPERATIONS	12
POWER-ON OPTIONS	14
SPECIAL FUNCTIONS INSTRUCTIONS	15
• Dynamic Recording	15
• Data Hold	17
• Relative (Zero)	17
• Analog Bargraph	18
• Auto Power Off and Sleep Mode	18
• Disable Auto Power Off	19
• Demonstrate Annunciator	19
• Backlit LCD for easy reading in the dark	19
• Continuity Function For Ohms Measurement	20
• Combination Display	21
• 1 ms Peak Hold	22

TABLE OF CONTENTS

	PAGE
HOW TO OPERATE	23
• AC CURRENT MEASUREMENT	23
• DISTRIBUTION TRANSFORMERS MEASUREMENT	24
• ADJUSTABLE SPEED MOTOR CONTROLLERS	25
• AC MOTOR CURRENT MEASUREMENT	26
• AC VOLTAGE MEASUREMENT	27
• RESISTANCE / CONTINUITY MEASUREMENT	28
• DIODE CHECK	29
GENERAL SPECIFICATIONS	30
ACDC-3000 ACCESSORIES AND REPLACEMENT PARTS	31
ELECTRICAL SPECIFICATIONS	32
CURRENT HARMONICS THEORY	35
• TRUE RMS MEASUREMENT	36
• WAVEFORM COMPARISON	36
MAINTENANCE	38
• SERVICE	38
• BATTERY REPLACEMENT	38
• CLEANING	38
SERVICE	40

SAFETY INFORMATION

□ SAFETY INFORMATION

To ensure that you use the meter safely, follow the safety guidelines listed below:

- Avoid working alone. Take precautions when working around moving parts.
- Use extreme caution when working around bare conductors or bus bars. Accidental contact with the conductor could result in electric shock.
- Use the meter only as specified in this manual, otherwise the protection provided by the meter may be impaired.
- Never measure current while the test leads are inserted into the input terminals.
- Do not use the meter if it looks damaged.
- Inspect the leads for damaged insulation or exposed metal. Check test lead continuity. Replace damaged leads.
- Disconnect the power and discharge all high-voltage capacitors before testing in the resistance, continuity, and diode function.
- Use caution when working above 60V DC or 25V AC RMS. Such voltages pose a shock hazard.
- When making measurements, keep your fingers behind the finger guards on the probe.
- Select the proper function and range for your measurement. To avoid damaging the meter when testing voltage above 350V AC RMS, disconnect the test leads from test points before changing functions.
- Read this operation manual completely before using the meter and follow all safety instructions.

A UNIQUE CLAMP-ON MULTIMETER

□ INTRODUCTION TO THE ACDC-3000

Measuring current accurately is a difficult job in today's industrial plants and commercial buildings. An increasing number of personal computers, adjustable speed motor drives, and other types of electronic equipment come on-line every day. These devices draw current in short pulses, and are referred to as non-linear loads.

Non-linear loads draw high peak currents, causing harmonics in the load current. This may result in unexplained circuit breaker tripping, or dangerous overheating of neutral conductors and transformers. Currents containing harmonics can only be accurately measured with a true-rms meter or clamp meter.

This clamp-on multimeter offers the combination of TRUE-RMS measurements (AC+DC TRUE RMS) and Frequency or Duty Cycle measurements needed to troubleshoot problems associated with both traditional and non-linear loads.

Frequency measurement helps detect the presence of harmonics in neutral conductors and determine whether they are the result of unbalanced phases or non-linear loads. The analog bar graph continues to display real-time current (or voltage) measurements while reading frequency (or Duty Cycle) on the digital display. This allows simultaneous monitoring of current loads and frequency (or Duty Cycle).

The ACDC-3000 CLAMP-ON MULTIMETER is shown in Figure 1. This meter has many functions which are shown below:

- Combination display: Frequency (Duty cycle) indication by digital display and Current (Voltage) indication by analog bar graph.
- Resolution of display adjustable: 4000/ 20000 counts.
- TRUE RMS measurement for non-linear and traditional loads.
- Both Current and Voltage can do DC+AC measurement.
- 1 ms Peak Hold feature to capture glitch or draw current in short pulse.
- Frequency and Duty cycle measurements help to easily analyze components of Amp or Volt signal.
- Wide range of Current measurement: 40, 400, 1000 A, AC+DC
- Wide range of Voltage measurement: 4, 40, 400, 600 V, AC+DC
- Wide range of Resistance measurement: 400, 4k, 40k, 400k, 4M, 40M Ω
- Dynamic Recording helps to record the variation of tests.
- Backlit display for easy reading in dark places.
- Hand Guard for prevention of accidental contact with conductors.
- Carrying case with shoulder strap
- Data Hold to freeze displayed digital value.
- Relative (zero) function
- Auto and Manual Ranging

USING THE METER SAFELY

□ WARNING

Read "SAFETY INFORMATION" before using the meter.

□ NOTE

Some typical automobile tests are provided in this manual. These tests are designed to help you understand how to use the Meter. Consult your car's service manual for the test procedures that apply to your particular car.

Your Clamp-on multimeter is a hand-held, battery-operated instrument for testing and troubleshooting automobile or power electronic systems. If the meter is damaged or something is missing, contact the place of purchase immediately.

A WARNING identifies conditions and actions that pose hazard(s) to the user; a CAUTION identifies conditions and actions that may damage the Meter. International electrical symbols used are explained in Table 1.

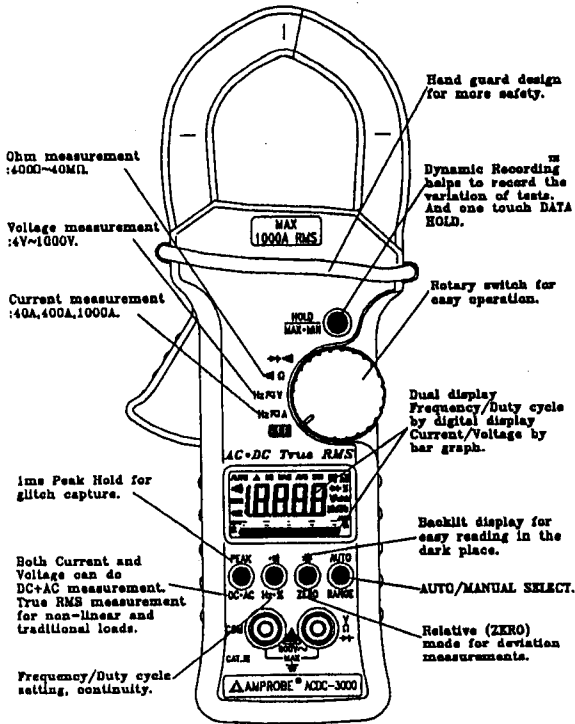

Figure 1. A Unique Clamp-ON Multimeter

~	AC - Alternating Current
—	DC - Direct Current
~ ~	AC and DC - Alternating and Direct Current
⊥	Ground
□	Double Insulation
⚠	See Explanation in the Manual

Table 1. International Electrical Symbols

LCD DISPLAY ILLUSTRATION

- 1) : Analog bar graph annunciator with scalar indicators
- 2) : Indicates the auto power off enable
- 3) : Indicates the battery power is weakening
- 4) : Direct Current or Voltage
- 5) : Alternating Current or Voltage
- 6) : Indicates the measurement is DC+AC (Alternating + Direct Current or Voltage)
- 7) : Indicates AUTO range Mode
- 8) : Zero(Delta) mode annunciator
- 9) : Data hold annunciator
- 10) : Dynamic recording mode, indicates the present reading
- 11) : Indicates the maximum reading
- 12) : Indicates the average reading
- 13) : Indicates the minimum reading
- 14) : Continuity function annunciator
- 15) : Diode/Audible continuity function annunciator
- 16) : Unit of Current measurement
- 17) : Unit of Voltage measurement
- 18) : Units of Resistance (ohm) measurement
- 19) : Units of Frequency measurement
- 20) : Units of Duty cycle measurement
- 21) : Used to indicate the range of Voltage, Current, Diode and Ohm measurements.
- 22) : Indicates ZOOM bar graph mode.

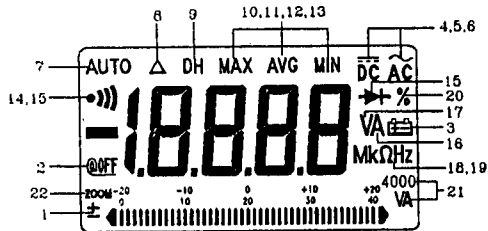

Figure 2. LCD Display

- 8 -

Getting Acquainted With Your Meter

□ ALIGNMENT MARKS

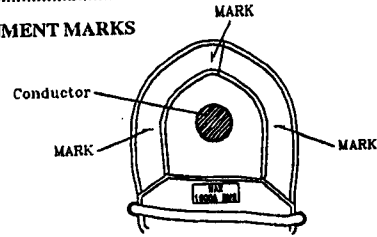

Figure 3. Alignment Marks

Put the conductor within the jaws on inside section of the indicated marks as much as possible (Figure 3), in order to meet the meter accuracy specifications.

□ Rotary Switch

To turn the meter on and select a function, turn the rotary switch (Figure 4) to a switch setting. The whole display lights for one second. Then the meter is ready for use. (If you press and hold down any pushbutton while turning the meter from OFF to ON, the display remains lit until the pushbutton is released.)

- 1) Power Off Position
- 2) DC, AC or DC+AC Current measurements.
- 3) DC, AC or DC+AC Voltage measurements.
- 4) Resistance or Continuity measurement.
- 5) Diode and Audible Continuity measurements.

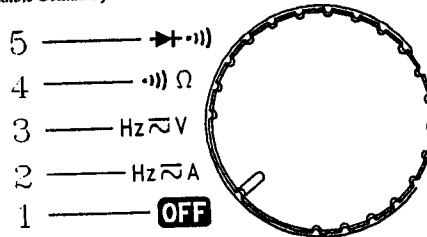

Figure 4. Rotary Switch

- 9 -

□ INPUT TERMINAL

WARNING

To avoid damaging the meter, do not exceed input limits shown below in Table 1:

ROTARY SWITCH FUNCTION	INPUT TERMINAL	INPUT LIMIT
ACV 4V - 750V	V- Ω - \rightarrow & COM	750V AC
DCV 4V - 1000V	V- Ω - \rightarrow & COM	1000V DC
DCA 40A - 1000A	Clamp Jaw	1000A RMS
ACA 40A - 1000A	V- Ω - \rightarrow & COM	600 DC/AC RMS
OHM (Ω)	V- Ω - \rightarrow & COM	600 DC/AC RMS
DIODE (\rightarrow \rightarrow \rightarrow)	V- Ω - \rightarrow & COM	750VAC
Duty cycle(%)	V- Ω - \rightarrow & COM	1000VDCAC
FREQUENCY (Hz)	V- Ω - \rightarrow & COM	1000VDCAC

Table 1. Input limit specification.

The meter has two input terminals (Figure 5) that are protected against overloads to the limits shown in the specifications.

- 1) Common terminal for all measurements.
- 2) Volts, Ohms, Diode test and Frequency(Duty Cycle) of Voltage measurements.

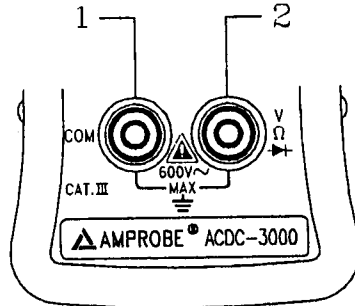

Figure 5. Input Terminal

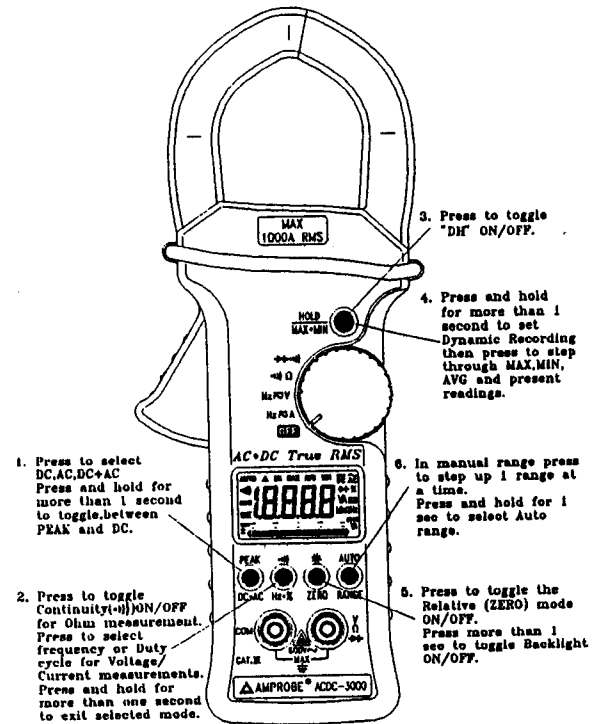

Figure 6. Push buttons

Push-button Operations

The operation of the push-buttons are outlined below. When a button is pushed, a display symbol lights, and beeper sounds. Turning the rotary switch to another switch setting resets all push buttons to their default states. The pushbuttons are shown in Figure 6(Page 11).

1) DC • AC/PEAK \odot :

DC, AC, DC+AC, Peak Test Select

- This pushbutton is used for selecting the measurement of either Direct source, Alternating source, DC+AC or 1 ms peak hold (glitch capture) function.
- Press button momentarily to step through DC, AC and DC+AC test.
- Press more than 1 second to toggle 1 ms peak hold test ON/OFF. Push the PEAK button momentarily to select peak+ or peak measurement after setting the peak mode.
- The display shows "DH MAX" to indicate the PEAK + and show "DH MIN" to indicate the PEAK-.
- To select the ZOOM mode, use Power-On Option (see page 14).
- The unit of each bargraph segment is changed from 100 counts/bar to 25 counts/bar to increase the resolution of the bargraph indication.

2) $\bullet \bullet \bullet$ (Hz • %):

Continuity(Frequency, Duty cycle)

- In Ohm test, press button momentarily to toggle $\bullet \bullet \bullet$ ON/OFF. The continuity buzzer sounds when test value is below 100 counts (10.0 Ω). Pushing this button for more than 1 second exits the continuity function and returns to the autoranging ohms measurement.
- For Volt or Amp test, press this button momentarily to enter Frequency (Hz), Voltage or Current is displayed by the bargraph. Press this button again to go from Frequency to Duty cycle test. Press this button for more than 1 second to return to Voltage or Current digital measurement.
- Press to re-start 1 ms peak hold test after setting peak mode.

3) DH \odot :

DATA HOLD or Refresh Data Hold

- The data hold function allows operator to hold the displayed digital value, but the analog bargraph continues showing present readings.
- If you select " Refresh Data Hold " by Power-ON Options, the reading is updated to the display automatically when the reading level changes. The beeper sounds a tone to remind user, that an update has occurred.
- Press this button momentarily to toggle DH on or off.

4) MAX • MIN \odot :

Dynamic Recording

- Records maximum, minimum, and calculates true average.
- Press this button for more than 1 second to toggle recording mode on or off.
- Press this button momentarily to cycle through MAXimum, MINimum, AVGerage and present (MAX AVG MIN) readings.
- The beeper sounds when a new maximum or minimum value is recorded.

5) ZERO / \ast \odot :

ZERO (Relative)/Backlight

- The relative function shows difference between the measured value and the stored value.
- Press to toggle zero(Δ) ON or OFF.
- Press this button for more than 1 second to toggle Backlight ON or OFF. Backlight turns off automatically after 30 seconds.

6) RANGE / AUTO \odot :

- In autorange press this button momentarily to select manual range and turn off the "AUTO" annunciator.
- In manual range, press this button momentarily to step up 1 range at one time, press this button for more than 1 second to select autorange.
- In autorange, the " AUTO " annunciator is lit and the meter will select an appropriate range for measurement being made. If a reading is greater than maximum available range, " OL " (overload) is displayed on the screen. The meter selects a lower range when reading is less than about 9% of full scale.
- Push this button momentarily to change measuring range and re-start the PEAK+ or PEAK- measurement after setting the peak mode.

POWER-ON OPTIONS

□ SELECTING POWER-ON OPTIONS

Some options can be selected only when you turn the meter on. These power-on options are listed in Table 2. To select power-on options, press and hold down pushbutton while turning the rotary switch to any ON position. Power-on options remain selected until the meter is turned off.

PUSHBUTTON	OPTION DESCRIPTION
DH ○ MAX • MIN	Demonstrate Annunciators To demonstrate the annunciators, Full annunciators are displayed. Press any buttons momentarily to exit demonstrate mode. Disable auto-power off In general, the auto-power off function turns the meter off if neither rotary switch nor push button is activated for 15 minutes. You can disable auto-power off function by this option. When auto-power off is disabled the meter will stay on continuously. Auto-power off is auto disable in Dynamic Recording. Enable " Refresh Data Hold".
PEAK ○ DC • AC	Select Zoom mode of Bargraph Display. In Zoom mode, the unit of bargraph is 25 counts/bar. In general, the unit of bargraph is 100 counts/bar.
AUTO ○ RANGE	Select 4 1/2 digit display. Full scale 19999 Counts for Volt, Diode, Ohm Measurements, 1 second response.
* ○ ZERO	Disables backlight, automatically turns off after 30 seconds.
•)) ○ Hz • %	Turns off all beeper functions.

Table 2. Power-ON Options

SPECIAL FUNCTIONS INSTRUCTIONS

This clamp-on multimeter provides the operator with various functions including:

- Dynamic Recording
- Data Hold
- Zero(Relative)
- Analog Bargraph
- Auto Power Off and Sleep Mode
- Disable Auto Power Off
- Demonstrate Annunciator of Display
- Backlit LCD for easy reading in the dark
- Continuity Function For Ohms Measurement
- Combination Display
- 1 ms Peak Hold

□ DYNAMIC RECORDING

The dynamic recording mode can be used to catch intermittent and turn on or turn off surges, verify performance, measure while you are away, or take readings while you are operating the equipment under test and can not watch the meter. The average reading is useful for smoothing out unstable or changing inputs, estimating the percent of time a circuit is operational, or verifying circuit performance.

The operational procedures are described below:

- 1) Press "MAX • MIN" for more than 1 second to enter the dynamic recording mode. The present value is stored to memories of maximum, minimum and average, and MAX AVG MIN annunciator turns on.
- 2) Press this button for more than 1 second to toggle recording mode on or off.
- 3) Press this button momentarily to cycle through maximum, minimum, average and present readings. The MAX, MIN, AVG or MAX AVG MIN annunciator turns on respectively to indicate what value is being displayed, see Figure 7.
- 4) The beeper sounds when a new maximum or minimum value is recorded.
- 5) If an overload is recorded the averaging function is stopped. An average value becomes " OL "(overload).
- 6) In dynamic recording mode, the auto power off feature is disabled and the "@OFF" turns off.

- 7) Select dynamic recording in auto range, it will record the value of MAX, MIN or AVG for different ranges.
- 8) The record speed of dynamic recording is about 100 milliseconds (0.1 second).
- 9) The average value is the true average of all measured values taken since the recording mode was entered.

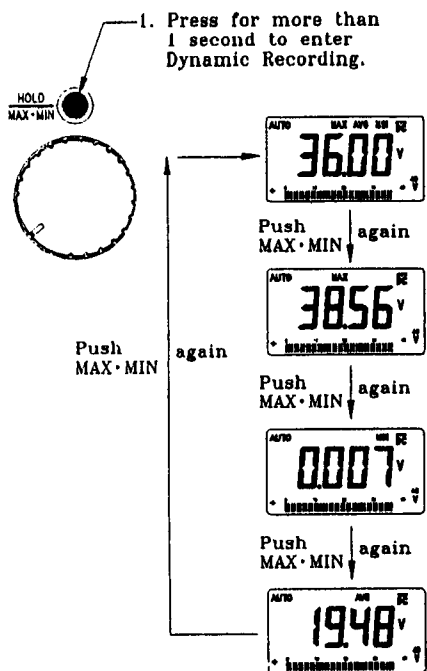

Figure 7. Display of Dynamic Recording

The data hold function allows operator to hold the displayed digital value, but the analog bargraph continues showing present readings. Press "DH" button to enter the data hold mode, and the "DH" is displayed. Press the button again to exit. The present reading is now shown.

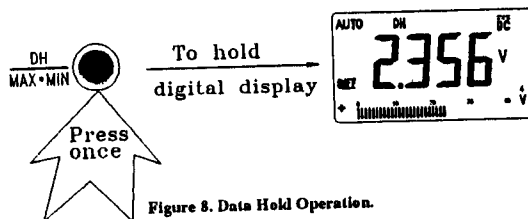

Figure 8. Data Hold Operation.

□ RELATIVE (ZERO)

The relative function subtracts a stored value from the present measurement and displays the result.

- 1) Press ZERO button momentarily to set the relative mode. This sets the display to zero and stores the displayed reading as a reference value, also "Δ" is displayed.
- 2) Both autorange or manual range can set relative mode. The relative mode can't be set when an overload has occurred.
- 3) Press this button again to exit the relative mode.
- 4) When the DC Current measurement mode is entered, the display reads a non-zero DC Current (positive or negative) value due to the presence of the Earth's Magnetism. This value is variable according to location measuring DC Current. You can use the relative function to Zero-Adjust the display.

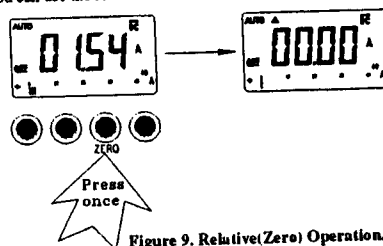
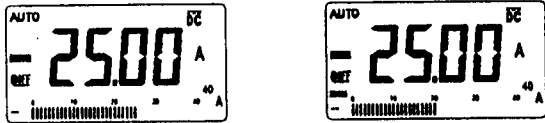

Figure 9. Relative (Zero) Operation.

□ ANALOG BARGRAPH

The analog bargraph display provides a 42 segment analog reading representation. The unit of the bargraph is 100 counts/bar except when in the ZOOM mode. The unit of the Bargraph is 25 counts/bar in the ZOOM mode. The bargraph is used to indicate AC voltage or Current value, when frequency or Duty cycle measurements are displayed.



Bar graph unit: 100 counts/Bar

Bar graph unit: 25 counts/Bar

Figure 10. Analog Bar Graph.

□ AUTO POWER OFF AND SLEEP MODE

Two step way for power saving:

- 1) The instrument may enter "sleep" mode within 15 minutes, if none of the following happens.
 - 1-1. Push buttons used.
 - 1-2. Measurement function changed.
 - 1-3. Dynamic recording set.
 - 1-4. 1 ms peak hold set.
 - 1-5. Disable auto power off with power-up option.
- 2) In sleep mode, the LCD will display a blinking "OFF . . ." signal.
 - 2-1. To wake-up sleep mode, press any push button for 0.5 sec or rotate rotary switch.
 - 2-2. Without wake-up, after 15 minutes, the meter will automatically shut off completely.
- 3) You must turn the rotary switch to the OFF position, then turn on to activate the meter after an auto power off.

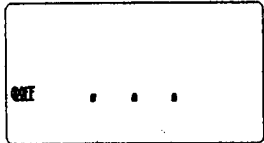

Figure 11. Sleep Mode

- 10 -

□ DISABLE AUTO POWER OFF

When the meter is to be used for long periods of time, the operator might want to disable the auto power off. Once the auto power off function is disabled, the meter will stay on continuously. The meter is shut off by turning the rotary switch to the off position.

To activate this function, press and hold the "DH/MAX MIN" button before switching the meter power on. When all annunciators are displayed, press any button momentarily to exit demonstrate mode, and the "@OFF" annunciator will be off.

□ DEMONSTRATE ANNUNCIATOR

To demonstrate the annunciators, press "DH/MAX MIN" button and turn on the meter simultaneously. All annunciators will be displayed. Press any button to exit demonstrate mode.

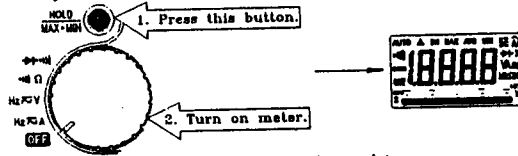

Figure 12. Demonstrate Annunciator.

□ BACKLIT DISPLAY FOR EASY READING IN THE DARK

Press * button for more than 1 second to toggle backlight ON/OFF.

Backlight turns off automatically after 30 seconds.

To disable backlight(off automatically after 30 seconds), use POWER-ON option (see page 14).

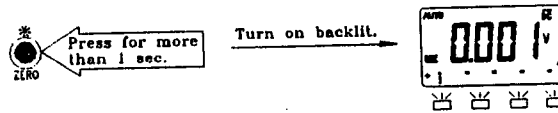

Figure 13. Backlit Display.

- 10 -

□ CONTINUITY FUNCTION FOR OHMS MEASUREMENT

In Ohm test, press $\bullet \gg$ button momentarily to toggle CONTINUITY function ON/OFF. The continuity range is 0-400.0 Ω . Momentarily pushing this button will only turn the beeper on/off. Pushing this button for more than 1 second will exit the continuity function and return to autoranging ohms measurement. When testing continuity, the beeper sounds if the resistance falls below 10 Ω .

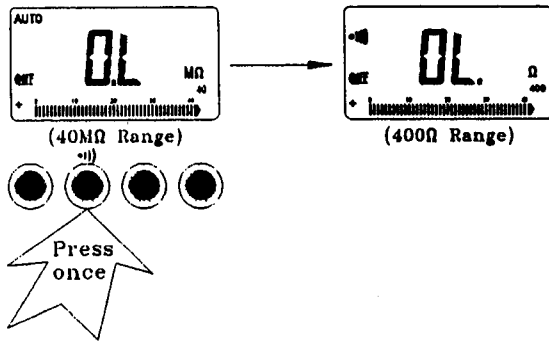

Figure 14. Continuity Operation.

□ COMBINATION DISPLAY

The frequency measuring mode helps detect the presence of harmonic currents in neutral conductors and determines whether these neutral currents are the result of unbalanced phases or non-linear loads. The analog bar graph continues to display real-time current measurements while reading frequency(or Duty Cycle) on the digital display. This allows simultaneous monitoring of current levels and frequency(or Duty Cycle).

For Voltage or Current test, press Hz \bullet % button momentarily to enter Frequency test. AC Voltage or Current is now displayed in bargraph. Press this button again to step through Frequency and Duty cycle test.

The frequency measurement is always in autorange and the voltage /current is a fixed range. You can select measuring range of Voltage or current by pressing RANGE button momentarily.

Press Hz \bullet % button more than 1 second to return to Voltage or Current measurement.

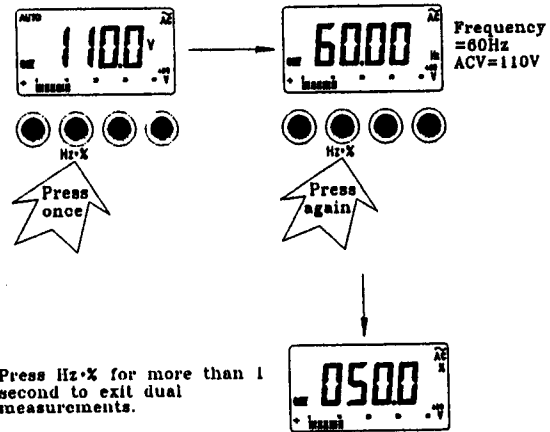

Figure 15. Combination Display for Voltage Measuring.

□ 1 ms Peak Hold

You can use this Meter to analyze components such as power distribution transformers and power factor correction capacitors. The additional features allow the measurement of the half-cycle peak current by using the 1 ms peak hold feature. This allows the determination of the crest factor:

$$\text{Crest factor} = \frac{\text{Peak value}}{\text{True RMS value}}$$

- 1) Press PEAK button for more than 1 second to toggle 1 ms peak hold mode ON/OFF.
- 2) Press PEAK button momentarily to select PEAK+ or PEAK- measurement after setting the peak mode.
- 3) The display shows "DH MAX" to indicate the PEAK + and shows "DII MIN" to indicate the PEAK -. See Figure 16. If the reading is "OL", then you can push RANGE button momentarily to change measuring range and re-start the PEAK+ or PEAK- measurement after setting the peak mode.
- 4) Press Hz • % button to re-set the 1 ms peak hold again after setting peak mode.

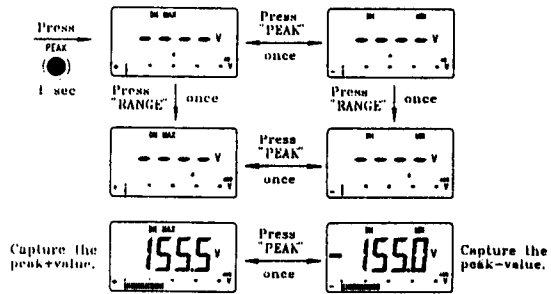

Figure 16. 1 ms Peak Hold Display.

- 22 -

HOW TO OPERATE

□ AC CURRENT MEASUREMENT

WARNING: MAKE CERTAIN THAT ALL TEST LEADS ARE DISCONNECTED FROM THE METER TERMINALS.

- 1) Set the rotary switch to "A".
- 2) Press DC • AC button momentarily to select AC Current measurement.
- 3) Press the handle to open jaws and clamp around a conductor. The most accurate reading will be obtained by keeping the conductor aligned with the centering marks on the jaws.
- 4) Read the display.

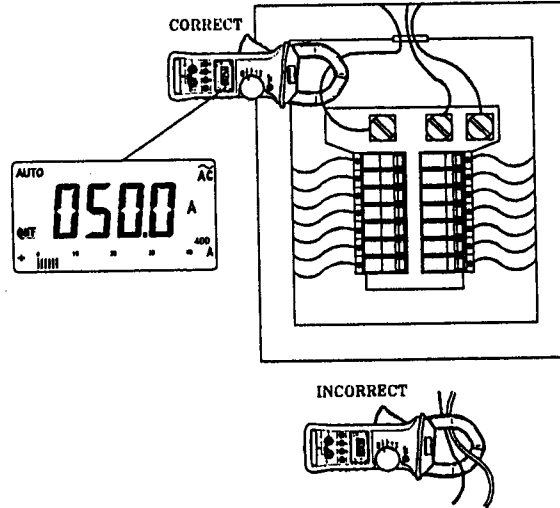

Figure 17. Measuring AC Current.

- 23 -

□ DISTRIBUTION TRANSFORMERS MEASUREMENT

You can measure excessive current, load balance between phases, true RMS and frequency of neutral current. True RMS measurement yields the effective value.

- 1) Set the rotary switch to " A ".
- 2) Press DC • AC button momentarily to select AC Current measurement. Clamp around a phase wire of the transformer. Be sure the clamp jaws are securely closed, or measurements will not be accurate.
- 3) Observe the display for true RMS current.
- 4) Repeat your measurement for each phase to determine balance. Unbalanced phases cause neutral currents.
- 5) Clamp around the neutral wire.
- 6) Observe the display for true RMS current reading. Any significant flow, with balanced phases, may indicate the presence of harmonic currents.
- 7) Press the Hz • % button momentarily to measure the frequency of the current in the neutral wire. Reading indicates the frequency of the dominant current. A 180Hz reading in a 60Hz system indicates the presence of 3RD harmonic current.
- 8) Press the DII button to freeze the digital display.
- 9) Press the DC • AC button more than 1 second to measure half-cycle peak to current (DH MAX displayed). Divide first reading into the second reading to determine crest factor. A crest factor other than 1.414 is an indication of harmonic current.
- 10) Press the MAX • MIN button for more than 1 second to enter record readings. Momentarily press to review maximum, minimum, and average values.
- 11) Press the MAX • MIN button for more than 1 second to exit recording.

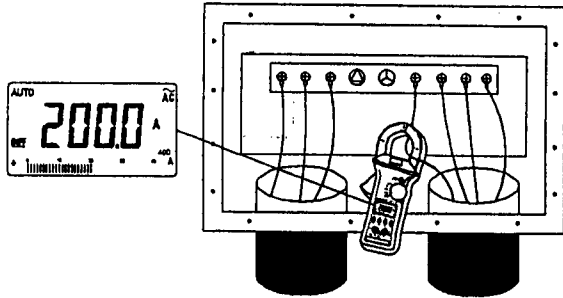

Figure 18. Measuring AC Current.

- 24 -

□ ADJUSTABLE SPEED MOTOR CONTROLLERS

You can measure input current, output current and frequency of adjustable speed motor controllers. The output current frequency is used to calculate the rotating speed of the motor, while input current frequency is used to measure the frequency of the power line. The frequency of the output current is important because the voltage frequency is often meaningless for the calculations of motor controller speed.

- 1) Set the rotary switch to " A ".
- 2) Press DC • AC button momentarily to select AC Current measurement.
- 3) Clamp around an input or output phase (as required), and run motor at desired speed. Be sure the clamp jaws are securely closed, or measurements will not be accurate.
- 4) Observe the display for true RMS current.
- 5) Measure an output phase of the motor controller and use Hz mode to measure frequency. Nominal motor speed is calculated by formula is shown below:
$$\text{RPM} = 120 F / P$$

F: measured frequency P: number of pairs of motor poles.
- 6) Press the MAX • MIN button for more than 1 second to record readings. To view readings, momentarily push MAX • MIN button.
- 7) Press the MAX • MIN button for more than 1 second to exit recording.

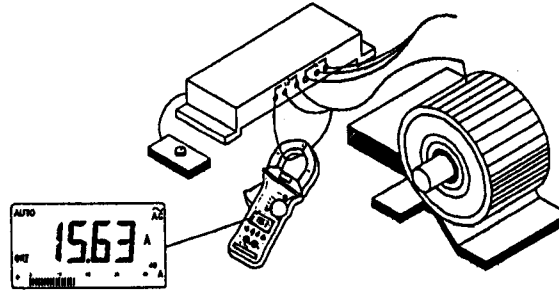

Figure 19. Measuring Input/Output AC Current of Controller.

- 25 -

□ AC MOTOR CURRENT MEASUREMENT

You can measure starting (inrush) current, running current, and current imbalance. Inrush current is typically 6 times the value of running current, depending on the motor type.

- 1) Set the rotary switch to "A".
- 2) Press DC • AC button momentarily to select AC Current measurement.
- 3) Clamp around a motor phase conductor. Be sure the clamp jaws are securely closed, or measurements will not be accurate.
- 4) When the motor reaches the desired speed, observe the running current.
- 5) Repeat your measurement for each motor phase. Unbalanced current may be caused by a voltage imbalance, or a shorted motor winding.
- 6) Press the PEAK button for more than 1 second to set 1 ms peak hold mode. (Note : default current range is 400.0A)
- 7) Clamp around a motor phase conductor. Be sure the clamp jaws are securely closed, or measurements will not be accurate.
- 8) Press Hz • % button to test the inrush current.
- 9) Turn the motor on. When the motor gets to the desired speed, observe the display for inrush current.
- 10) If the reading is "OL", then you can push RANGE button momentarily to change measuring range. Turn off the motor. Repeat step 8 through 9.
- 11) Repeat your measurement from step 7 through 10 for each motor phase.
- 12) Press the PEAK button for more than 1 second to exit 1 ms peak hold mode.

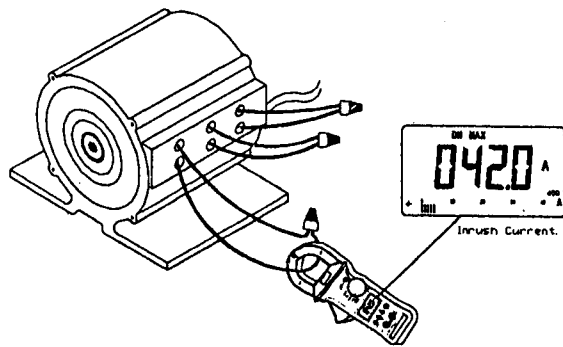

Figure 20. Measuring AC Motor Current.

- 26 -

□ AC VOLTAGE MEASUREMENT

- 1) Set the rotary switch to "V".
- 2) Insert the black test lead to "COM" terminal and red test lead to "V Ω →" terminal.
- 3) Press DC • AC button momentarily to select AC Voltage measurement.
- 4) Touch the probes to the test points and read the display.

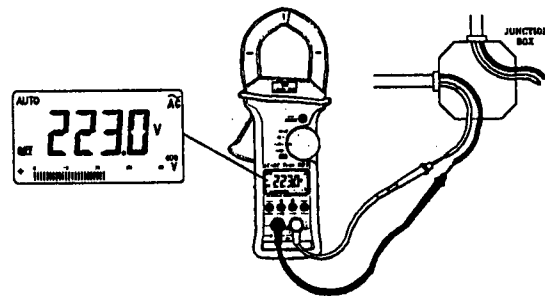

Figure 21. Measuring Voltage.

- 27 -

□ RESISTANCE / CONTINUITY MEASUREMENT

- 1) Set the rotary switch to "Ω"
- 2) Insert the black test lead to "COM" terminal and red test lead to "V Ω →" terminal.
- 3) Press "HOLD" button momentarily to enter continuity function if required.
- 4) Touch the test leads to the circuit (Fuse Cartridge or other) and read resistance value in the display. The beeper sounds if continuity reading is less than 10.0Ω.
- 5) The relative (delta) function can compensate for test lead resistance before taking a measurement.

CAUTION:

When the input is not connected (open circuit), the OL (over load) is displayed. When checking in-circuit resistance, be sure the power is removed and the capacitor has been discharged before measuring. Be sure that the contact between the probes and the circuit is clean. Dirt, oil, paint, rust or other foreign matter seriously affects resistance.

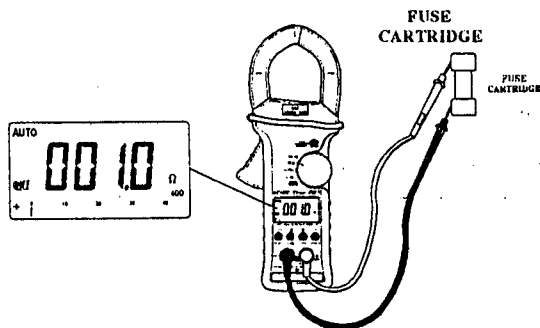

Figure 22. Measuring Resistance and Continuity.

□ DIODE CHECK

A good diode allows current to flow in one direction only. To test a diode, turn the power off, remove the diode from the circuit, and proceed as follows:

- 1) Set the rotary switch to "→|←" position.
- 2) Insert the black test lead to "COM" terminal and red test lead to "V Ω →|←" terminal.
- 3) Touch the red lead to the positive side of the diode and the black lead to the negative side. The meter can display diode voltage drops to approximately 2.5 V. A typical voltage drop is 0.5 - 0.8 V and causes the meter to beep once.
- 4) Reverse the probes and measure the voltage across the diode again. If the diode is:
 - Good: "OL" is displayed.
 - Shorted: Near 0 V drop is displayed in both directions, and the beeper sounds continuously.
 - Open: "OL" is displayed in both directions.
- 5) Repeat step 3 and 4 for other diodes.

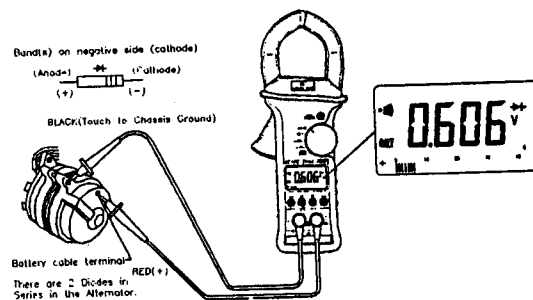



Figure 23. Measuring Diode on Alternator.

GENERAL SPECIFICATIONS

Display: 4 1/2 digits liquid crystal display (LCD) with maximum reading of 4000/20000 selectable. 43 segments analog bar graph and full annunciator. Automatic polarity indication.

Functions: DCV, ACV, DCA, ACA, DC+ACV or A, OHM, Diode check, Audible Continuity, Frequency and Duty cycle test.

Measuring rate: 3.3 times per second for 4000 counts.
1 time per second for 20000 counts.
0.5-2 times per second for frequency/Duty cycle tests.

Low battery indicator: The "" appears when the battery voltage drops below 7V (approx.)

Operating temperature: 0°C to 50°C (32°F to 120°F), 0 - 80% R.H.

Storage temperature: -20°C to 60°C (-4°F to 140°F), 0 - 80% R.H.
with BATTERY REMOVED.

Temperature coefficient: 0.12 % / °C (from 0°C to 18°C or 28°C to 50°C)

Power supply: Single standard NEDA1604, JIS006P, IEC6F22 carbonzinc or alkaline type 9V battery.

MAX. Jaw Opening: To Accommodate Circuit Cables 2" (50.8 mm) diameter.

Dimension: 32 (H) x 64 (W) x 260 (L) mm
1.26"(H) x 2.52"(W) x 10.24"(L)

Weight: 840 grams with batteries included.
(1.85 lbs with batteries included.)

Accessories: Test leads (pair), Manual, Battery and Carrying case.

Safety: Designed to comply with IEC1010-1 Instrument Category(Overvoltage Category) III, 600V, Pollution Degree 2, Product will be marked when approved.

ACDC-3000 Accessories and Replacement Parts

Amprobe P/N	Description
DTL-3000	ACDC-3000 Test Leads
CC-ACDC	Carrying Case
MN-1604	9 Volt Alkaline Battery
978752	Instruction Manual

ELECTRICAL SPECIFICATIONS

Accuracy is given as $\pm\%$ of reading + no. of least significant digits at $23^{\circ}\text{C} \pm 5^{\circ}\text{C}$, with relative humidity Less than 80% R.H.

In the 4 1/2 digit mode, multiply the number of least significant digits(dgt) by 10.

DC VOLTAGE

Range	Resolution	Accuracy	Overload Protection
4V	1mV	$\pm(0.5\%rdg+3dgt)$	1200V DC or 850V AC RMS
40V	10mV		
400V	100mV		
1000V	1V	$\pm(0.8\%rdg+3dgt)$	

• Input Impedance: 10M Ω

AC VOLTAGE (TRUE RMS : From 10% to 100% of range.)

Range	Resolution	Accuracy		Overload Protection
		(@40-400Hz)	(@400-2KHz)	
4V	1mV	$\pm(1.5\%rdg+5dgt)$	$\pm(3\%rdg+5dgt)$	1200V DC or 850V AC rms
40V	10mV			
400V	100mV			
750V	1V			

• Input Impedance: 10M Ω // less than 100pF

Crest factor: >3:1

AC+DC VOLTAGE (TRUE RMS : From 10% to 100% of range.)

Range	Resolution	Accuracy		Overload Protection
		(@40-400Hz)	(@400-2KHz)	
4V	1mV	$\pm(2.5\%rdg+9dgt)$	$\pm(3.5\%rdg+9dgt)$	1200V DC or 850V AC rms
40V	10mV			
400V	100mV			
750V	1V			

• Input Impedance: 10M Ω // less than 100pF

Crest factor: >3:1

VOLTAGE (1 ms PEAK HOLD)

Specified accuracy \pm 40 digits for changes > 1 ms in duration.

Range	Resolution	Accuracy	Overload Protection
4V	1mV	$\pm(1.5\%rdg+43dgt)$	1200V DC or 850V AC rms
40V	10mV		
400V	100mV		
1000V	1V		

• Input Impedance: 10M Ω

DC CURRENT

Range	Resolution	Accuracy
40A	0.01A	$\pm(2\%rdg+30dgt)$
400A	0.1A	$\pm(1.5\%rdg+3dgt)$
1000A	1A	$\pm(2\%rdg+5dgt)$

AC CURRENT (TRUE RMS: From 10% to 100% of range.)

Range	Resolution	Accuracy	
		(@40Hz-65Hz)	(@65Hz-2KHz)
40A	0.01A	$\pm(2\%rdg+10dgt)$	$\pm(3\%rdg+10dgt)$
400A	0.1A	$\pm(2\%rdg+5dgt)$	$\pm(3\%rdg+5dgt)$
1000A	1A	$\pm(2.5\%rdg+5dgt)$	$\pm(3\%rdg+5dgt)$

• Crest factor: >3:1

AC+DC CURRENT (TRUE RMS: From 10% to 100% of range.)

Range	Resolution	Accuracy	
		(@40Hz-65Hz)	(@65Hz-2KHz)
40A	0.01A	$\pm(4\%rdg+40dgt)$	$\pm(5\%rdg+40dgt)$
400A	0.1A	$\pm(3.5\%rdg+9dgt)$	$\pm(4.5\%rdg+9dgt)$
1000A	1A	$\pm(4.5\%rdg+9dgt)$	$\pm(5\%rdg+9dgt)$

• Crest factor: >3:1

CURRENT (1 ms PEAK HOLD)

Specified accuracy \pm 40 digits for changes > 1 ms in duration.

Range	Resolution	Accuracy
40A	0.01A	$\pm(2\%rdg+70dgt)$
400A	0.1A	$\pm(2\%rdg+43dgt)$
1000A	1A	$\pm(2\%rdg+43dgt)$

RESISTANCE

Range	Resolution	Accuracy	MAX. Test Voltage	Overload Protection
400 Ω	0.1 Ω	$\pm(1\%rdg+3dgt)$	3.3V	600V DC/ AC rms
4k Ω	1 Ω			
40k Ω	10 Ω			
400k Ω	100 Ω			
4M Ω	1k Ω			
40M Ω	10k Ω			

• Instant Continuity: Built-in buzzer sounds when resistance is less than 10.0k Ω .

□ FREQUENCY (AC coupling)

Range	Resolution	Accuracy	Minimum Input Frequency
200Hz	0.01Hz	±(0.2%rdg+4dg)	10Hz
2kHz	0.1Hz		
20kHz	10Hz		
200kHz	100Hz		

• Overload protection: 1200V DC/850Vrms AC; < 1000000 VxHz

FREQUENCY COUNTER SENSITIVITY		
INPUT RANGE	MINIMUM SENSITIVITY (RMS SINEWAVE)	
	40 Hz-2 kHz	10 Hz-200 kHz
(Maximum input for specified accuracy = 10 x Range or 1000V)		
40A	3A	3A(to 2kHz)
400A	30A	30A(to 2kHz)
1000A	300A	300A(to 2kHz)
4V	0.3V	0.7V
40V	3V	7V
400V	30V	70V (≤140 kHz)
1000V	300V	700V (≤140 kHz)
DUTY CYCLE 0.0 to 99.9%		
Accuracy: Within ±(0.3% per kHz + 0.3%) of full scale for a 5V square wave input on the 4V dc range		

□ DIODE CHECK

Range	Resolution	Accuracy	Test Current	Test Voltage
→	1mV	±(1.0%rdg+2dg)	approx. 1.65mA	<3.3V

• Overload protection: 600V DC/RMS AC

□ AUDIBLE CONTINUITY TEST

Range	Resolution	Accuracy	Test Current	Test Voltage
→ •))	1mV	built-in buzzer sounds when reading is below approx. 100 mV	approx. 1.65mA	<3.3V

• Overload protection: 600V DCRMS AC

CURRENT HARMONICS THEORY

True-RMS current is very important because it directly relates to the amount of heat dissipated in wiring, transformers, and system connections as well as variations in loads. Most clamp meters in the market measure average current, not true RMS current, even if this average value is displayed on a scale calibrated in rms. These average-sensing meters are accurate only for sinusoidal signals.

All current signals are virtually distorted in some way. The most common is harmonic distortion caused by non-linear loads such as household electrical appliances, personal computers or speed controls for motor drives. Harmonic distortion causes significant currents at frequencies that are at odd multiples of the power line frequency. Harmonic current puts a substantial impact on the neutral wires of wye-connected power distribution systems.

In most countries a power distribution system uses commercial 3-phase 50Hz/60Hz power applied to a transformer with a delta-connected primary, and a wye-connected secondary. The secondary generally provides 120V AC from phase to neutral, and 208V AC from phase to phase. To balance the loads for each phase was a big headache for the electrical system designer, historically.

The vector addition of the currents in the transformer's neutral wire was zero or quite low (because perfect-balance was rarely achieved) in a well-balanced system, because devices connected to it were incandescent lighting, small motors, and other devices that presented linear loading. The result was an essentially sine-wave current in each phase and a low neutral current at a frequency of 50Hz/60Hz.

But, devices such as TV sets, fluorescent lighting, video machines, and microwave ovens are commonly drawing power line current for only a fraction of each cycle so that they cause non-linear loading and subsequent non-linear current. This generates odd harmonics of the 50Hz / 60Hz line frequency. Therefore, the current in the transformer of today contains not only a 50Hz (or 60Hz) component, but a 150Hz (or 180Hz) component, a 250Hz (or 300Hz) component, and the other significant harmonic components up to a 750Hz (or 900Hz) component and beyond.

The vector addition in a properly-balanced power distribution system feeding non-linear loads may still be quite low. But, the addition does not cancel all the harmonic currents. The odd multiples of the 3rd harmonic (called the "TRIPLENS") are, particularly, added together in the neutral. These harmonics can form a total RMS current in the transformer's neutral wire that is normally 130% of the total RMS current measured in any individual phase, whose theoretical maximum is 173%. For example, phase currents of 80 amperes may cause harmonic current in the neutral is most commonly the 3rd harmonic. The electrical designer must consider the following 3 issues when he designs a power distribution system containing harmonic current.

1. The AC neutral wires must be of sufficient gauge to allow for harmonic current.
2. The distribution transformer must have additional cooling to continue operation at its rated capacity, if it is not harmonic-rated. This is because the harmonic current in the secondary neutral wire is circulating in the delta-connected primary winding, after it is reflected to the primary winding. The circulating harmonic current heats up the transformer.
3. Phase current harmonics are reflected to the primary winding and they continue back towards the power source. This can cause distortion of the voltage wave so that any power factor correction capacitors on the line can be easily overloaded.
We can use this Meter to analyze components such as power distribution transformers and power factor correction capacitors. The additional features allow the measurement of the half-cycle peak current by using the 1ms peak hold feature. This allows the determination of the crest factor:

$$\text{Crest factor} = \text{Peak value} / \text{True RMS value}$$

4. For a free video on Amprobe's HA-2000 series harmonic/waveform analyzer please contact Amprobe directly.

☐ TRUE RMS MEASUREMENT

The meter measures the true RMS value of AC voltages and currents. In physical terms, the RMS (root-mean-square) value of a waveform is the equivalent DC value that causes the same amount of heat to be dissipated in a resistor. True RMS measurement greatly simplifies the analysis of complex AC signals. Since the RMS value is the DC equivalent of the original waveform, it provides a reliable basis for comparing dissimilar waveforms.







By contrast, many meters use average-responding AC converters rather than true RMS converters. The scale factor in these meters are adjusted so that they display the RMS value for a harmonic-free sine wave. However, if a signal is not sinusoidal, average-responding meters do not display correct RMS readings.

☐ WAVEFORM COMPARISON

Table 3 illustrates the relationship between AC and DC components for common waveforms, and compares readings for true RMS meters and average-responding meters. For example, consider the first waveform, a 1.414V (zero-to-peak) sine wave. Both this Clamp-on meter and RMS-calibrated average-responding meters display the correct RMS reading of 1.000V (the DC component equals 0). However, consider the 2V (peak-to-peak) square wave, both types of meter correctly measure the DC component (0V). The clamp meter correctly measures the AC component (1.000V). The average-responding meter measures 1.111V, which amounts to an 11% error.

Since average-responding meters have been in use for many years, one may have accumulated test or reference data based on them. The conversion factors in Table 3 should help you convert between the two measurement methods.

Table 3. WAVEFORM COMPARISON CHART

AC-COUPLED INPUT WAVEFORM	PEAK VOLTAGE		METERED VOLTAGES			DC AND AC TOTAL RMS
	PK-PK	0-PK	AC COMPONENT ONLY		DC COMPONENT ONLY	TRUE RMS= $\sqrt{ac^2 + dc^2}$
			RMS CAL*	OUR METER		
SINE 	2.828	1.414	1.000	1.000	0.000	1.000
RECTIFIED SINE (FULL WAVE) 	1.414	1.414	0.421	0.436	0.900	1.000
RECTIFIED SINE (HALF WAVE) 	2.000	2.000	0.779	0.771	0.636	1.000
SQUARE 	2.000	1.000	1.111	1.000	0.000	1.000
RECTIFIED SQUARE 	1.414	1.414	0.875	0.707	0.707	1.000
RECTANGULAR PULSE 	2.000	2.000	$4.42K^2$	2K	2D	$2\sqrt{D}$
TRIANGLE SAWTOOTH 	3.464	1.732	0.962	1.000	0.000	1.000

* RMS CAL IS THE DISPLAYED VALUE FOR AVERAGE RESPONDING METERS THAT ARE CALIBRATED TO DISPLAY RMS FOR SINE WAVES

MAINTENANCE

WARNING

To avoid electrical shock, do not perform any servicing unless you are qualified to do so.

□ SERVICE

If the instrument fails to operate, check battery, test leads, etc. and replace as necessary. If the instrument still does not operate, double check operating procedure as described in this instruction manual. When servicing, use only specified replacement parts.

WARNING

To avoid electrical shock or damage to the meter, do not get water inside the case. Remove the test leads and any input signals before opening the case.

□ BATTERY REPLACEMENT

The meter is powered by a single 9V battery, with NEDA1604, S006P, IEC6F22 carbonzinc or alkaline battery. Replace battery if the low battery sign (⎓) is displayed and flashing. Use the following procedure to replace the battery:

1. Unclamp the jaw from the conductor, turn it off using the rotary switch and disconnect the test leads from external equipment.
2. Loosen screw on battery cover, then pull up the cover slightly, see Figure 24.
3. Pull and Move the cover to right direction, see Figure 25.
4. Replace the defective battery.
5. Reverse the procedure of opening cover to close the battery cover.

□ CLEANING

To clean the instrument, use a soft cloth dampened in a solution of mild detergent and water. Do not spray cleaner directly onto the instrument, since it may leak into the cabinet and cause damage. Do not use chemicals containing benzene, toluene, xylene, acetone or similar solvents.

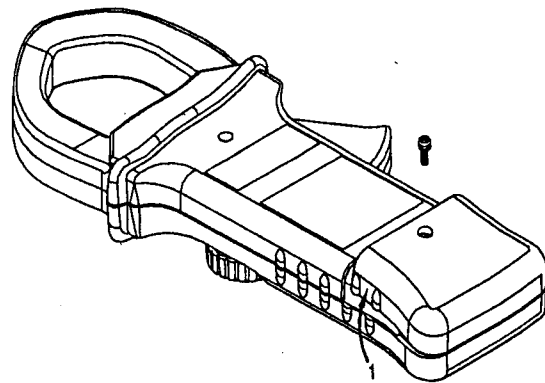

Figure 24. Step 1 of Battery Replacement.

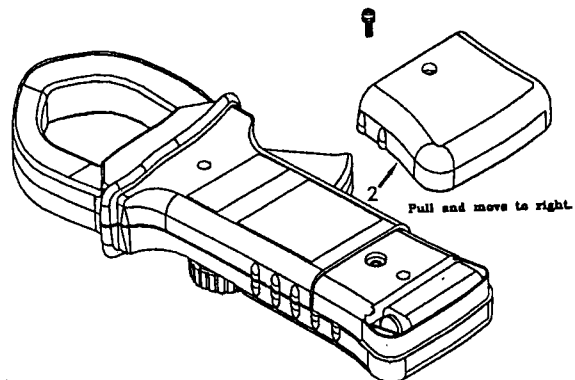

Figure 25. Step 2 of Battery Replacement.