

SolderSleeve One-Step Wire and Cable Terminators Installation Procedures for CWT and B-155 Products

1.0 Introduction

SolderSleeve one-step terminators provide electrical termination in a wide variety of interconnect applications. One-step terminator capabilities include terminating wires to component terminals, ground wires to cable shields, terminating coaxial cable, and wire-to-wire splicing.

A precisely engineered, fluxed solder preform within the heat-shrinkable thermoplastic sleeve provides a completely soldered, strain-relieved, encapsulated termination. The one-piece design of one-step terminators simplifies installation, while their transparent insulation sleeves make inspection easy.

2.0 Application Equipment

Equivalent tools may be used.

| | |
|---|--------------------------------------|
| Steinel HL-1802E, HL1910 or HL2010 Hot-Air Gun | IR-550 Mark II Infrared Heating Tool |
| CV-5300 Hot-Air Gun | MiniRay Infrared Heating Tool |
| CV-5000 Thermogun | Process Belt Heaters |
| AA-400 Superheater | Holding Fixture AD-1319 |

3.0 Part Selection, According to Application

Select correct part number from the SolderSleeve One-Step Wire and Cable Terminators Selection Guide (H54335) or consult the technical data sheet (or Specification Control Drawing) of the product (shield terminations, wire-to-wire splices, wire to component terminals or for coax terminators).

4.0 Termination Procedure

WARNING

Follow installation instructions carefully. Use adequate ventilation and avoid charring or burning during installation. Charring or burning the product will produce fumes that may cause eye, skin, nose and throat irritation. Consult Material Safety Data Sheets RAY5103 (for CWT products) and RAY5104 (for B-155 products) for further information.

WARNING

The heating tool and the assembly become hot during the installation of the SolderSleeve One-Step Wire and Cable Terminators. To prevent burns, allow tool and the assembly to cool down before handling.

4.1 Shield Terminations**4.1.1 Cable Preparation**

1. Remove length specified in Table I of the cable jacket at the point where the termination is to be made.

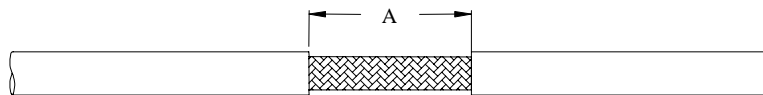
*Center Stripped**End Stripped*

2. Remove length specified in Table I of insulation from the end of the ground lead. (If part has pre-installed lead, omit this step.)

**4.1.2 Assembly**

1. Position the one-step soldersleeve shield terminator so that the solder preform is centered over the exposed shield.
2. Position the lead to be attached between the solder and the exposed shield.
3. Allow the application equipment to reach the operating temperature.
4. Place the assembly centrally in the reflector.
5. Heat the solder preform until it melts and forms a fillet between the lead and the shield.

Table I. Cable Jacket and Wire Insulation Stripped Length.

| RoHS Compliant Shield Terminator | Shield Terminator | Size | A ±0.5 [±0.002] | B ±0.5 [±0.002] | Minimum Overlap |
|----------------------------------|-------------------|-------|--------------------|--------------------|-----------------|
| B-155-XX | CWT-XX | 3 | 7.0 [0.276] | 6.0 [0.236] | 5.5 [0.217] |
| B-155-XX-1000 | CWT-XX-1000 | 5 | 9.0 [0.354] | 8.0 [0.315] | 7.0 [0.276] |
| B-155-XX-35-22-5 | CWT-XX-W122-5 | 6 | 10.0 [0.394] | 9.0 [0.354] | 7.5 [0.300] |
| B-155-XX-35-22-9 | CWT-XX W122-9 | 7 | 11.0 [0.433] | 10.0 [0.394] | 8.5 [0.335] |
| | | 9 | 12.0 [0.472] | 11.0 [0.433] | 9.0 [0.354] |
| | | 11 | 13.0 [0.512] | 12.0 [0.472] | 10.0 [0.394] |
| | | 13 | 17.0 [0.670] | 16.0 [0.630] | 14.0 [0.551] |
| B-155-XX-S | CWT-XX-S | 3, 5 | 7.0 [0.276] | 6.0 [0.236] | 5.5 [0.217] |
| | | 7, 11 | 9.0 [0.354] | 8.0 [0.315] | 7.0 [0.276] |
| B-155-15XX | CWT-15XX | All | 12.5 [0.492] | 12.5 [0.492] | 9.5 [0.374] |
| B-155-38XX | CWT-38XX | | | | |
| B-155-XXXX-WX | CWT-XXXX-WX | | | | |

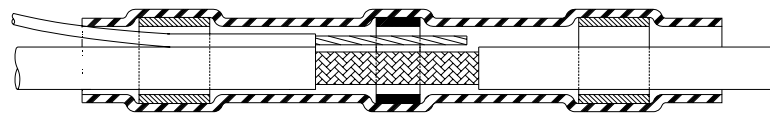

Center Stripped

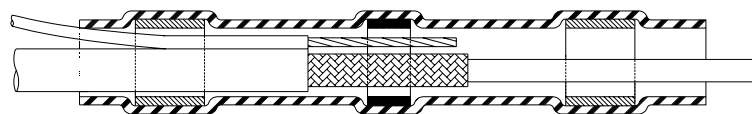

End Stripped

4.1.3 Inspection

1. Positioning: The ground lead conductor should overlap the shield minimum length specified in Table I.
2. Heating: The solder ring shape should not be visible and a solder fillet, at least 4.5 [0.188] long for CWT-15XX, CWT-38XX and CWT-XXXX-WX, B-155-15XX, B-155-38XX and B-155-XXXX-WX, should be visible on one side of the lead. Lack of a solder fillet may indicate overheating.
3. Damage: The sleeve should not be split or cut and no wire strands should poke through the sleeve.



Unacceptable: Insufficient heat.
Contour of solder perform is visible.



Acceptable: Fillet is clearly visible between the lead and shield.

4.2 Wire to Wire (In-Line) Splices

4.2.1 Wire Preparation

1. Wires from up to 18 AWG [1.5mm^2] having 19 or fewer strands: Remove 9.5 [0.375] of insulation from all wires to be spliced.



2. All other wires: Remove 12.5 [0.500] of insulation and pre-tin the exposed conductors with solder.



4.2.2 Assembly

1. Overlap the exposed conductors and position the one-step terminators so that the solder preform is centered over the conductors.

© 2005-2006 Tyco Electronics Corporation. All rights reserved.

- For a small gauge wires, (up to 1mm^2), and when a mechanical attachment is required, secure the 2 wire ends, by twisting them together. Align carefully the strands in order to avoid any poke through of the sleeve. See Fig. 1 and Fig. 2.

In other cases, align wires in such a manner that all strands are parallel. Then, slide the sleeve over the splice area and center the solder preform of the sleeve at the center of the splice length.

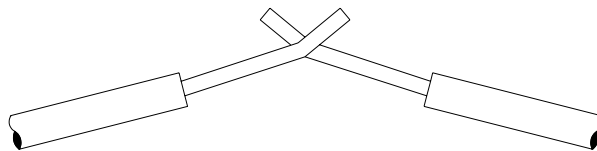

Fig. 1

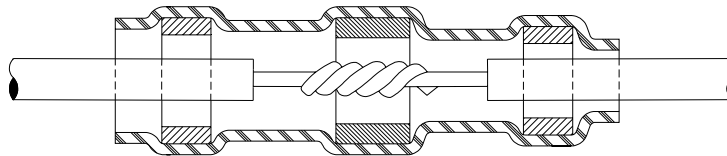
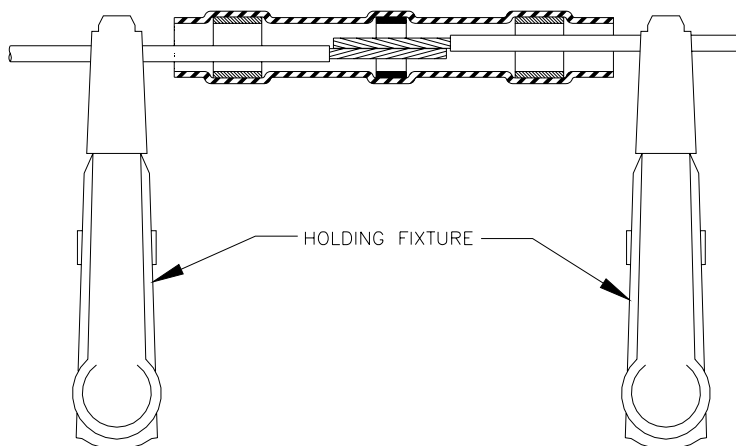

Fig. 2

2. The splicing operation is made easier by using the recommended holding fixture (AD-1319), keeping the wires aligned and the sleeve positioned during the termination.



3. Heat solder preform until it melts and forms a fillet between the conductors.

4.2.3 Inspection

1. Positioning: Wires stripped 9.5 [0.375] should overlap each other at least 6.0 [0.250]. On wires stripped 12.5 [0.500] the overlap should be 9.5 [0.375].
2. Heating: The solder ring shape should not be visible and a solder fillet, at least 4.5 [0.180] long, should be visible on one side of the leads. Fillet length should be 8.0 [0.315] for 12.5 [0.500] stripped wires. Lack of solder fillet may indicate overheating.
3. Damage: The sleeve should not be split or cut and no wire strands should poke through the sleeve. Fillet length should be 8.0 [0.315] for 12.5 [0.500] stripped wires.



Unacceptable: Insufficient heat.
Contour of solder perform is visible.



Acceptable: Solder has lost all appearance of ring shape.
There is a definite fillet visible along the wire interface.

4.3 Coaxial Cable Termination

4.3.1 Cable preparation

1. Remove 19.0 [.750] of the jacket.
2. Remove 6.0 [.235] of the shield and dielectric to expose the conductor.
3. Cut shield 12.5 [.500] from cable jacket and fold back over the cable jacket.

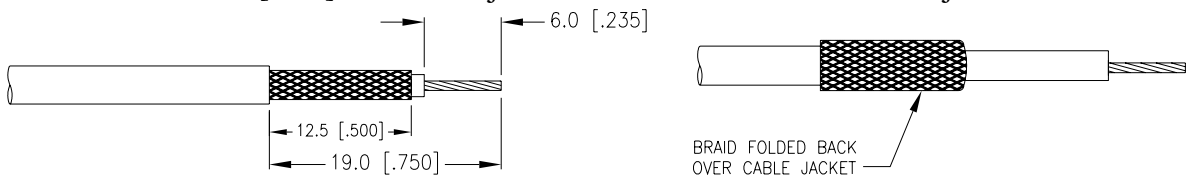

© 2005-2006 Tyco Electronics Corporation. All rights reserved.

Note:

For making connections directly to printed circuit boards using CWT-38XX-W3 or B-155-38XX-W3 part numbers, use cable preparation described for shield termination in Section 4.1. Adjust strip length of center conductor to accommodate desired spacing between PCB mounting holes.

4.3.2. Assembly

1. Position the smaller or center conductor one-step terminator so that the end is against the folded shield, and the solder preform is visually centered over the exposed center conductor.



2. Heat solder preform until it melts and forms a fillet between the conductors. Allow assembly to cool.
3. Refold the shield so that it lies on the center conductor termination.
4. Center the larger one-step shield terminator over the shield.

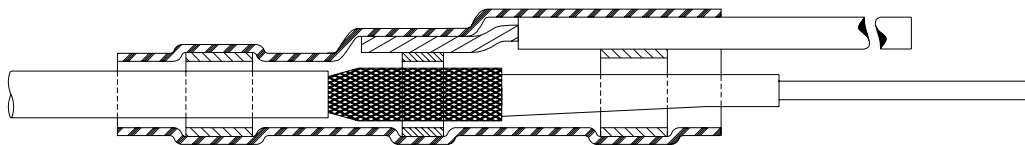

5. Heat solder preform until it melts and forms a fillet between the lead and the shield. Lack of a solder fillet may indicate overheating.

4.3.3 Inspection

1. Inner conductor splice: Inspect as for wire splices in Section 4.2.3
2. Shield terminations: Inspect as for shield terminations in Section 4.1.3

4.4 Wire To Connector Terminals Or Component Leads (Discrete Wire Terminations)

4.4.1 Recommended Heating Tool: Raychem AA-400 Super Heater

© 2005-2006 Tyco Electronics Corporation. All rights reserved.

4.4.2 Wire Preparation

A: Wires smaller than 18 AWG [1.5mm^2]

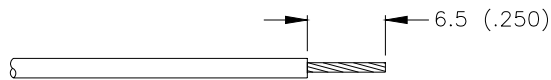

1. Trim terminal/lead to 8.0 ± 1.5 [0.315 ± 0.060].
2. Remove 6.5 [0.250] of wire insulation.
3. Pre-tin conductors if more than 19 strands.

B: Wires 18 AWG [1.5mm^2] and larger

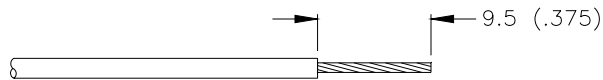

1. Trim terminal/lead to 11.0 ± 1.5 [0.435 ± 0.060].
2. Remove 9.5 [0.375] of wire insulation.
3. Pre-tin conductors.

4.4.3 Assembly

1. Position the one-step terminator over the connector terminal or component lead so that the necked down end is against the connector or component. The solder preform must not extend beyond the terminal/lead end.

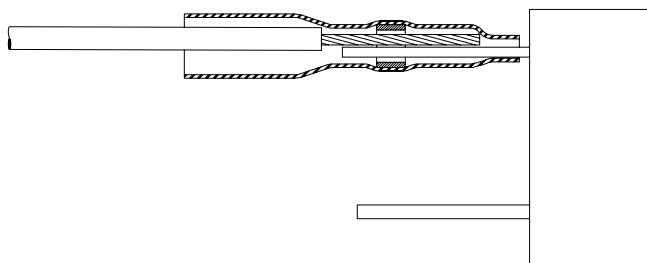

2. Insert the wire to be attached so that it bottoms against the step in the sleeve. The wire insulation must end between the top of the terminal and the end of the sleeve.
3. Heat solder preform until it melts and forms a fillet between the wire and the terminal.

4.4.4 Inspection

1. Positioning: 18 AWG [1.5mm^2] conductor should overlap the terminal/lead at least 4.5 [0.180]. Larger wires should overlap at least 5/16 in [8 mm].

© 2005-2006 Tyco Electronics Corporation. All rights reserved.

2. Heating: The solder ring shape should not be visible and a solder fillet, at least 4.5 [0.180] long, should be visible on one side of the leads. Fillet length should 8.0 [0.315] for larger wires. Lack of a solder fillet may indicate overheating.
3. Damage: The sleeve should not be split or cut and no wire strands should poke through the sleeve.



Unacceptable: Insufficient heat.

Contour of solder preform is visible.

Contour of terminal and/or lead is obscured by solder.

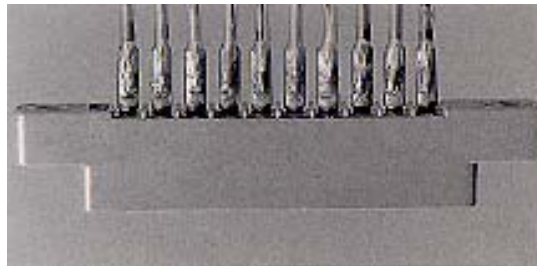

Acceptable: Fillet is clearly visible between terminal and lead.

4.5 In-line Component Termination (CWT-200X and B-155-200X)

4.5.1 Wire Preparation

1. Remove 8.0 [0.315] of insulation from wires to be spliced.



© 2005-2006 Tyco Electronics Corporation. All rights reserved.

4.5.2 Assembly

1. Overlap the exposed conductor and the component pin and position the CWT-200X-A or B-155-200X-A sub-assembly so that the solder preform is centered over the conductors.
2. Use a holder to keep the wire and component aligned during heating.
3. Heat solder preform until it melts and forms a fillet between the conductors.

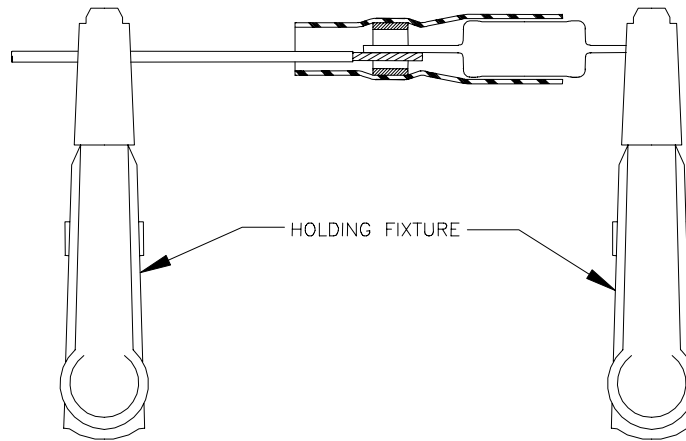

4. Overlap the other exposed conductor and component pin and position the CWT-200X-B or B-155-200X-B sub-assembly so the solder preform is centered over the conductors.
5. Use a holder to keep the wire and component aligned during heating.
6. Heat solder preform until it melts and forms a fillet between the conductors.

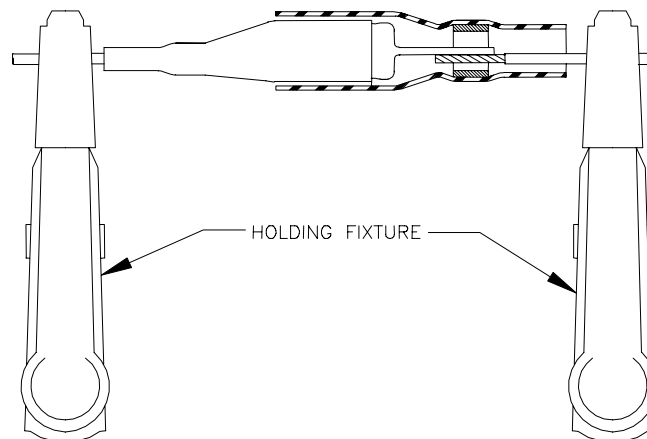

© 2005-2006 Tyco Electronics Corporation. All rights reserved.

4.5.3 Inspection

1. Positioning: Wires stripped 8.0 [0.315] should overlap each other at least 6.5 [0.250].
2. Heating: The solder ring shape should not be visible and a solder fillet, at least 4.5 [0.180] long, should be visible on one side of the leads.
3. Damage: The sleeve should not be split or cut and no wire strands should poke through the sleeve. Fillet length should be 8.0 [0.315] for 12.5 [0.500] stripped wires.



Unacceptable: Insufficient heat.
Contour of solder perform is visible.



Acceptable: Solder has lost all appearance of ring shape.
There is a definite fillet visible along the wire interface.

DISCLAIMER

All of the above information, including illustrations, is believed to be reliable. Users, however, should independently evaluate the suitability of each product for their application. Tyco Electronics makes no warranties as to the accuracy or completeness of the information, and disclaims any liability regarding its use. Tyco Electronics' only obligations are those in the Standard Terms and Conditions of Sale for this product, and in no case will Tyco Electronics be liable for any incidental, indirect, or consequential damages arising from the sale, resale, use or misuse of the product.