

Electronic housing - ME 12,5 UTG/FE GN - 2906801

Please be informed that the data shown in this PDF Document is generated from our Online Catalog. Please find the complete data in the user's documentation. Our General Terms of Use for Downloads are valid (<http://download.phoenixcontact.com>)



Lower part of housing, fully assembled, with integrated functional earth ground contact, (housing closed) and metal foot catch.

Product Features

- Tool-free mounting
- Low design width with a high number of positions
- Large assembly area
- Recessed labeling areas
- Same PCB geometry for all design widths
- Inflammability class V0 according to UL 94
- Fast mounting on DIN rails according to EN 60715
- Material and part identification embossed on the housing (recyclability)
- Cost savings thanks to easy device production
- Functional earth ground contact (EMC) integrated in the housing base
- Optional BUS connection integrated in the housing, for either parallel or serial contacting
- Metal foot catch
- Electronic components can be partially removed



Key commercial data

Packing unit	1 1
GTIN	 4 017918 131401
Weight per Piece (excluding packing)	40.59 GRM
Custom tariff number	85472000
Country of origin	Germany

Technical data

General

Electronic housing - ME 12,5 UTG/FE GN - 2906801

Technical data

General

Housing type	Component housing
Housing material	Polyamide
Color	green

Ambient conditions

Ambient temperature (operation)	-40 °C ... 105 °C
---------------------------------	-------------------

Dimensions

Length	99 mm
Constructional height	114.5 mm
Width	12.5 mm

Technical data

Inflammability class according to UL 94	V0
Power dissipation at 20°C in the horizontal mounting position	4.3 W 7.1 W
Number of positions	8

Classifications

eCl@ss

eCl@ss 4.0	27180401
eCl@ss 4.1	27180401
eCl@ss 5.0	27180506
eCl@ss 5.1	27180506
eCl@ss 6.0	27180802
eCl@ss 7.0	27182702
eCl@ss 8.0	27182702

ETIM

ETIM 2.0	EC001031
ETIM 3.0	EC001031
ETIM 4.0	EC001031
ETIM 5.0	EC001031

UNSPSC

UNSPSC 6.01	31261501
UNSPSC 7.0901	31261501
UNSPSC 11	31261501
UNSPSC 12.01	31261501

Electronic housing - ME 12,5 UTG/FE GN - 2906801

Classifications

UNSPSC

UNSPSC 13.2	31261501
-------------	----------

Approvals

Approvals

Approvals

UL Recognized

Ex Approvals

Approvals submitted

Approval details

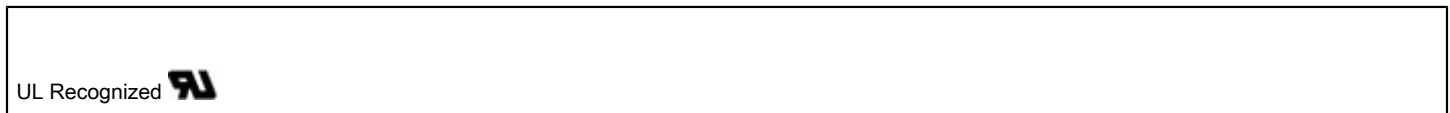

Accessories

Accessories

Coding element

Coding star - CR-MSTB - 1734401



Coding section, inserted into the recess in the header or the inverted plug, red insulating material

Coding profile - CP-MSTB - 1734634



Coding profile, is inserted into the slot on the plug or inverted header, red insulating material

Electronic housing - ME 12,5 UTG/FE GN - 2906801

Accessories

Filler plug

Electronic housing - ME B-12,5 MSTBO GN - 2906856



Filler plugs, for unoccupied terminal points

Electronic housing - ME B-12,5 MKDSO GN - 2906872



Filler plugs, for unoccupied terminal points

Electronic housing - ME B-12,5 MKDSO GN - 2906872



Filler plugs, for unoccupied terminal points

Mounting material

Components of electronic housing - ME-SAS - 2853899



Shield connection clamp for printed circuit terminal block

Electronic housing - ME 12,5 UTG/FE GN - 2906801

Accessories

Electronic housing - ME LPZS - 2906911



PCB stop, for soldering onto PCB

Components of electronic housing - ME-SAS - 2853899



Shield connection clamp for printed circuit terminal block

Electronic housing - ME LPZS - 2906911



PCB stop, for soldering onto PCB

PCB

Electronic housing - ME LP - 2906908

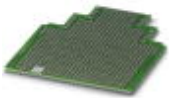

PCB, for custom fitting, with contact to DIN rail (EN 60715)

Electronic housing - ME LP - 2906908

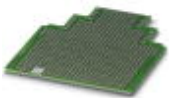

PCB, for custom fitting, with contact to DIN rail (EN 60715)

Electronic housing - ME 12,5 UTG/FE GN - 2906801

Accessories

Printed circuit board terminal

Printed-circuit board connector - MKDSO 2,5/ 2-R - 1707195



PCB terminal block, Nominal current: 24 A, Nom. voltage: 400 V, Pitch: 5 mm, Number of positions: 2, Connection method: Screw connection, Mounting: Soldering, Conductor/PCB connection direction: 0 °, Color: green, Article with lateral pin exit

Required add-on products

Electronic housing - ME 12,5 OT-MSTBO SET - 2907428

Housing set upper part, complete with COMBICON headers and screw plugs for full equipping.



Electronic housing - ME 12,5 OT-MSTBO GN - 2906814



Upper part of housing, for COMBICON connection, double-level.

Electronic housing - ME 12,5 OT-MKDSO SET - 2907457

Housing upper part, complete with PCB terminal blocks for full assembly. 8-pos., housing width: 12.5 mm



Electronic housing - ME 12,5 OT-MKDSO GN - 2906830



Housing upper part, for printed circuit terminal block connection

Electronic housing - ME 12,5 UTG/FE GN - 2906801

Accessories

Drawings

Dimensioned drawing

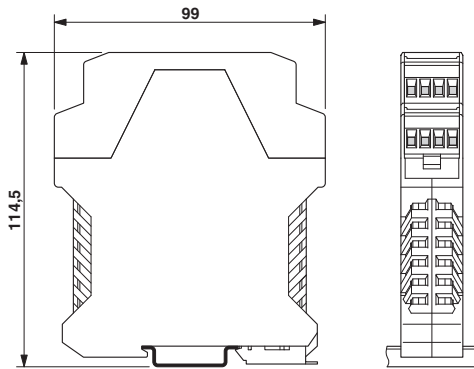

Dimensioned drawing

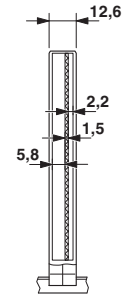

Inner housing dimensions, electronic housing ME 17,5 ...

Dimensions of the electronic housing ME... with double-level upper part

Dimensioned drawing

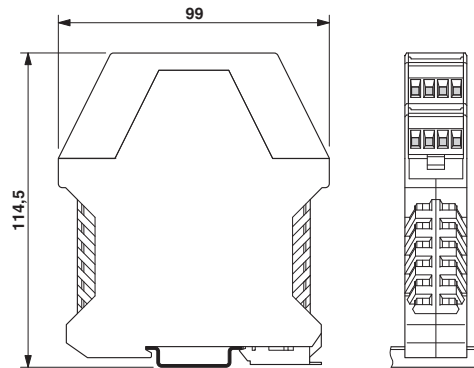

Dimensions of the electronic housing ME... with double-level upper part

Electronic housing - ME 12,5 UTG/FE GN - 2906801

Dimensioned drawing

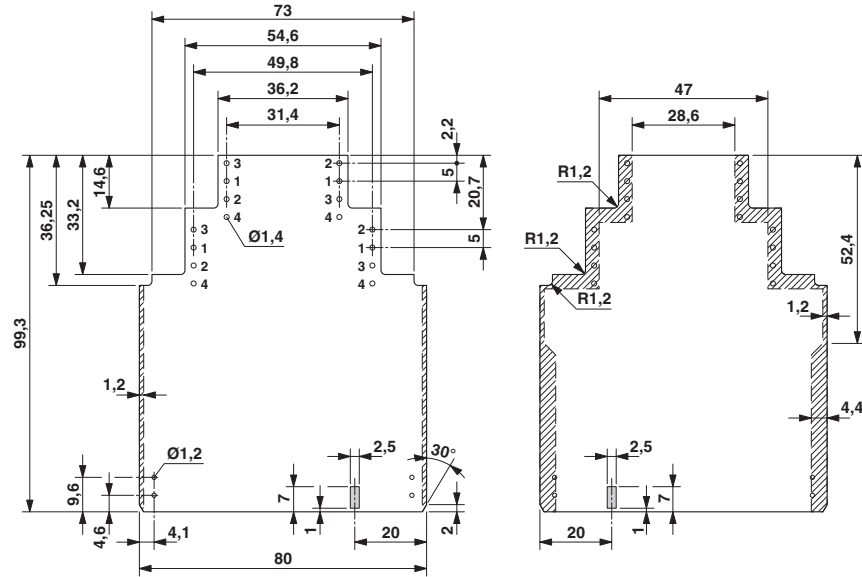

Dimensional drawing of the ME... printed circuit board if the double level upper part is used