

3100 – 6000 MHz Single Band Antenna (UWB)

Part Number: 1513381-1

Product Facts

- Universal antenna module assembly.
- RoHS compliant

Recommendations

- Antenna is to be mounted on a metal chassis.
- Panel thickness must be between .8mm and 1mm.
- Performance and bandwidth is dependant on chassis size.

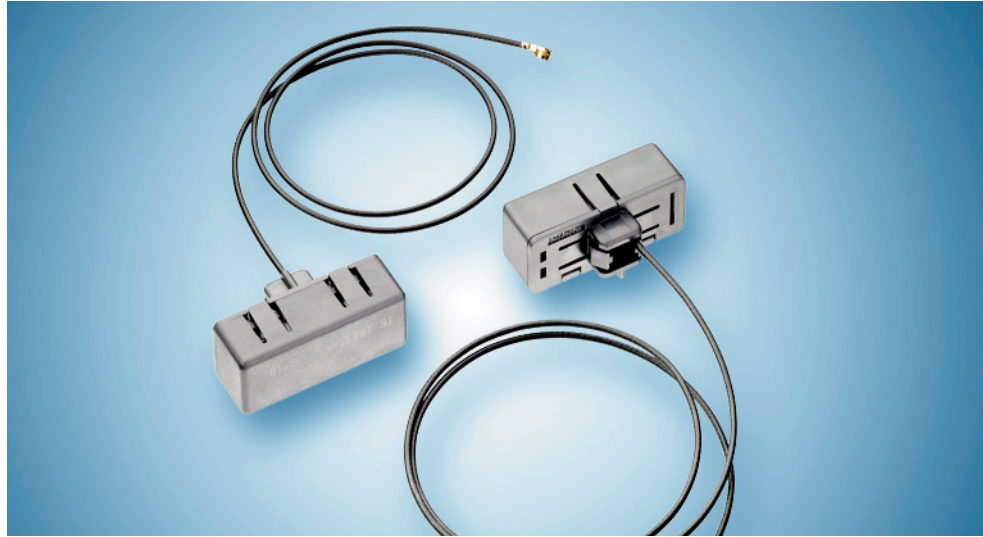

Specifications

Frequency Range (MHz)	3100 – 6000
Peak Gain	4 dBi
VSWR	< 3.0:1
Polarization	Linear
Power Handling	10 Watt cw
Feed Point Impedance	50 Ohms unbalanced
Size	29.00 mm x 12.00 mm x 10.00 mm
Weight	< 5.5 g.
Mounting	Universal Antenna Module See page 2
Keep Out Area	See diagram on page 2
Cable / Connector	365 mm length. 1.13 mm dia. with U.F.I connector
Note	Data shown was taken on a nominal size metal chassis

Test Orientation in Free Space

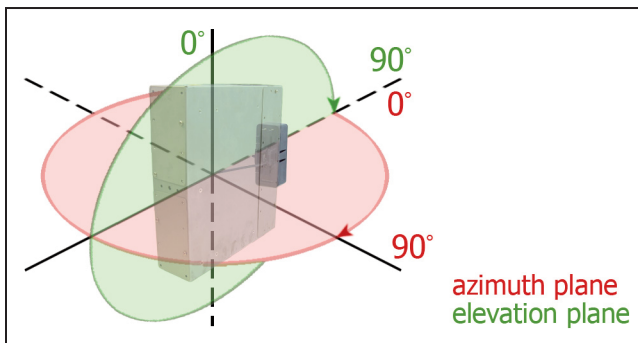

VSWR

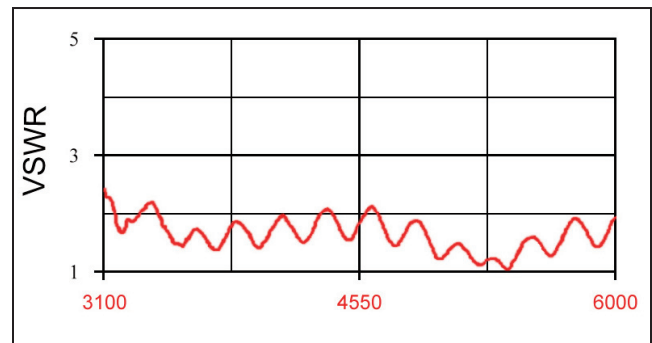

Azimuth

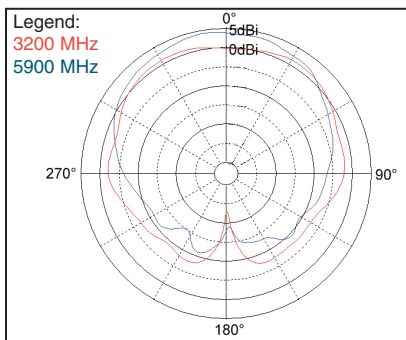

Elevation

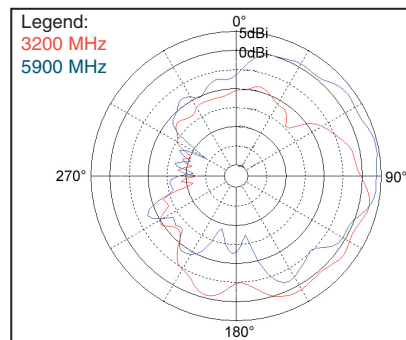

Efficiency

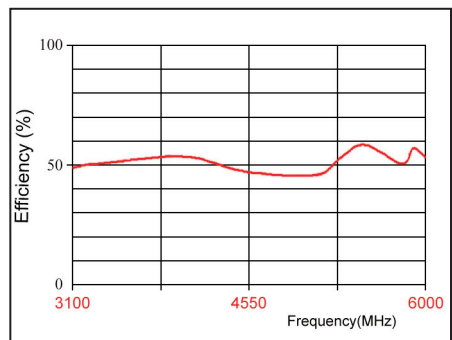

3100 – 6000 MHz Single Band Antenna (UWB)

Part Number: 1513381-1

Mounting Guide

NOTE:
Panel thickness must be between 0.8 mm and 1 mm.

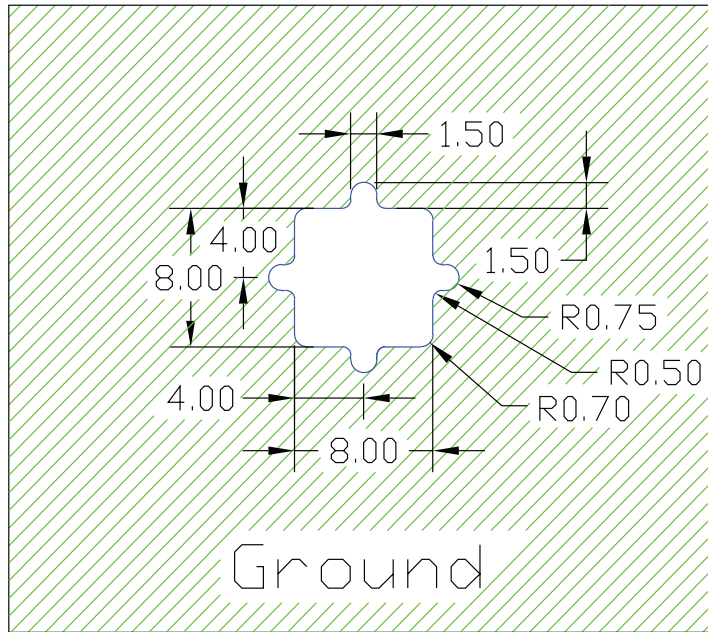

NOTES: 1. Antenna must be mounted on a metal chassis.
2. For more information please call TE.

Dimensions: mm
Diagram is not to scale

Keep Out Area

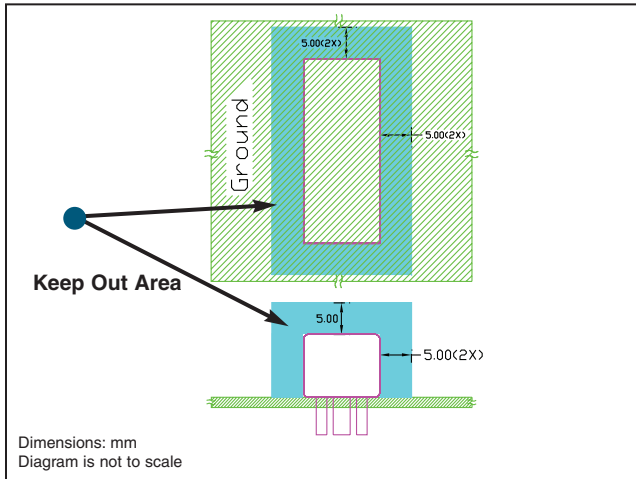

Dimensions: mm
Diagram is not to scale

Approx. Dimensions

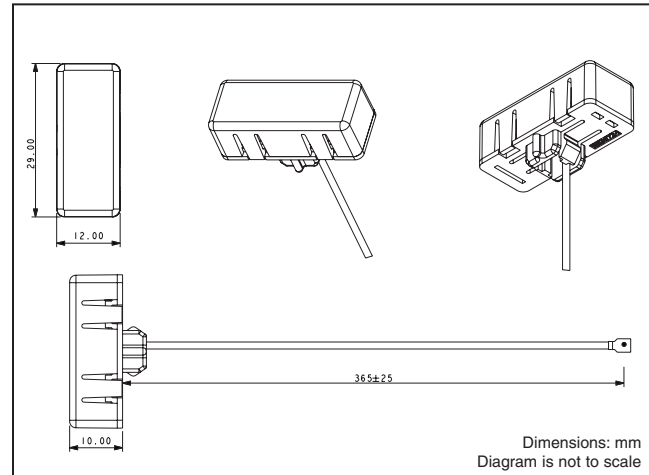

Dimensions: mm
Diagram is not to scale

© 2011 Tyco Electronics Corporation. All Rights Reserved..

3-1773459-4-CIS-PDF-03-11

TE (logo) and TE Connectivity are trademarks of the TE Connectivity group of companies and its licensors.

Other logos, product and Company names mentioned herein may be trademarks of their respective owners.

While TE has made every reasonable effort to ensure the accuracy of the information in this catalog, TE does not guarantee that it is error-free, nor does TE make any other representation, warranty or guarantee that the information is accurate, correct, reliable or current. TE reserves the right to make any adjustments to the information contained herein at any time without notice. TE expressly disclaims all implied warranties regarding the information contained herein, including, but not limited to, any implied warranties of merchantability or fitness for a particular purpose. The dimensions in this catalog are for reference purposes only and are subject to change without notice. Specifications are subject to change without notice.

Consult TE for the latest dimensions and design specifications.

9565 Soquel Drive
Aptos, CA 95003
(+ 831) 662-1174
<http://www.antenna.te.com>