

AN11006

Single stage 2.3_2.7GHz LNA with BFU730F

Rev. 4.0 — 21 June 2016

Application note

Info	Content
Keywords	BFU730F, LNA, 2.3-2.7 GHz, WiMAX, WLAN, ISM, LTE, High linearity.
Abstract	<p>The document provides circuit, layout, BOM and performance information on 2.3-2.7 GHz LNA equipped with NXP's BFU730F wide band transistor.</p> <p>This Application note is related to evaluation board OM7690/BFU730F,598 12nc 934065627598</p>



Revision history

Rev	Date	Description
1.0	20110106	Initial document
2.0	20110710	Schematic updated
3.0	20121120	Chapter added about switching time
4.0	20160621	Small updates

Contact information

For additional information, please visit: <http://www.nxp.com>

For sales office addresses, please send an email to: salesaddresses@nxp.com

1. Introduction

The BFU730F is a discrete HBT that is produced using NXP Semiconductors' advanced 110 GHz fr SiGe:C BiCmos process. SiGe:C is a normal silicon germanium process with the addition of Carbon in the base layer of the NPN transistor. The presence of carbon in the base layer suppresses the boron diffusion during wafer processing. This allows steeper and narrower SiGe HBT base and a heavier doped base. As a result, lower base resistance, lower noise and higher cut off frequency can be achieved.

The BFU730F is one of a series of transistors made in SiGe:C.

BFU710F, BFU760 and BFU790 are the other types, BFU710 is intended for ultra low current applications. The BFU760F and BFU790F are high current types and are intended for application where linearity is key.

The BFU7XXF are ideal in all kind of applications where cost matters. It also gives design flexibility.

2. Requirements and design of the 2.3-2.7GHz LNA

The BFU730 2.3-2.7GHz LNA EVB simplifies the evaluation of the BFU730 wideband transistor, for this frequency range, in which e.g. WLAN, Bluetooth, WiMax, LTE etc systems are present. The EVB enables testing of the device performance and requires no additional support circuitry. The board is fully assembled with BFU730, including input- and output matching, to optimize the performance. The input match is a compromise between best noise figure and good Input return loss. The board is supplied with two SMA connectors for input and output connection to RF test equipment.

Table 1. Target spec.
Target specification of the 2.3-2.7 GHz LNA.

Vcc	Icc	NF	Gain	IRL	ORL
3	10	<1dB	>18	>10	>10
V	mA	dB	dB	dB	dB

3. Design

The 2.3_2.7 GHz LNA consists of one stage grounded emitter BFU730F amplifier. For this amplifier 11 external components are used, for matching, biasing and decoupling.

The design has been conducted using Agilent's Advanced Design System (ADS). The 2D EM Momentum tool has been used to co-simulate the PCB. Results are given in paragraph 4.5. The LNA shows a gain of 20 dB, NF of 0.8 dB, input P1dB of -16.5 dBm and an input IP3 of 1.5 dBm

The LNA shown in this application note is unconditional stable 10 MHz-20 GHz.

3.1 BFU730F 2.3-2.7 GHz LNA-ADS Simulation circuit

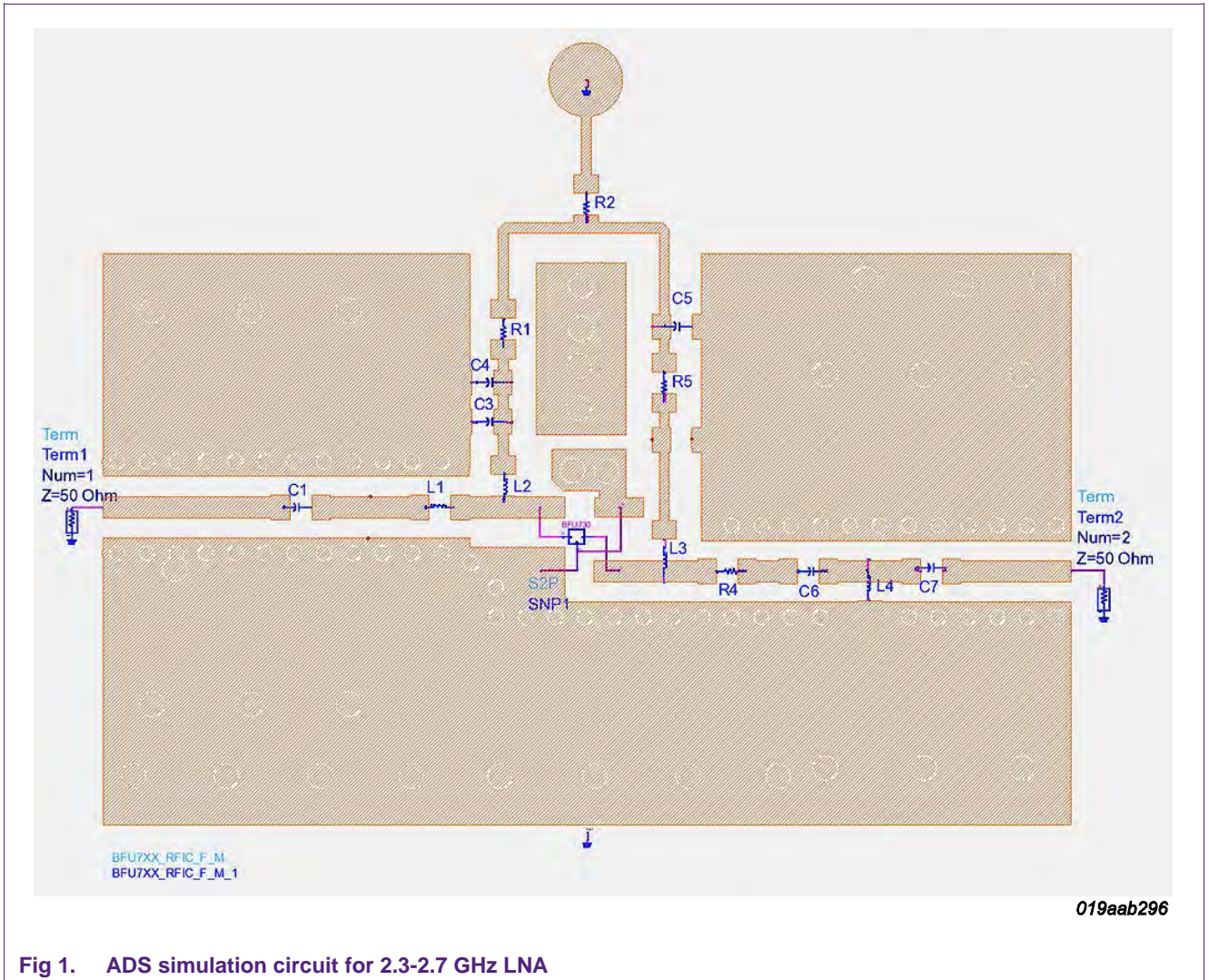

Fig 1. ADS simulation circuit for 2.3-2.7 GHz LNA

3.2 BFU730F 2.3-2.7 GHz LNA - ADS Gain and match simulation results

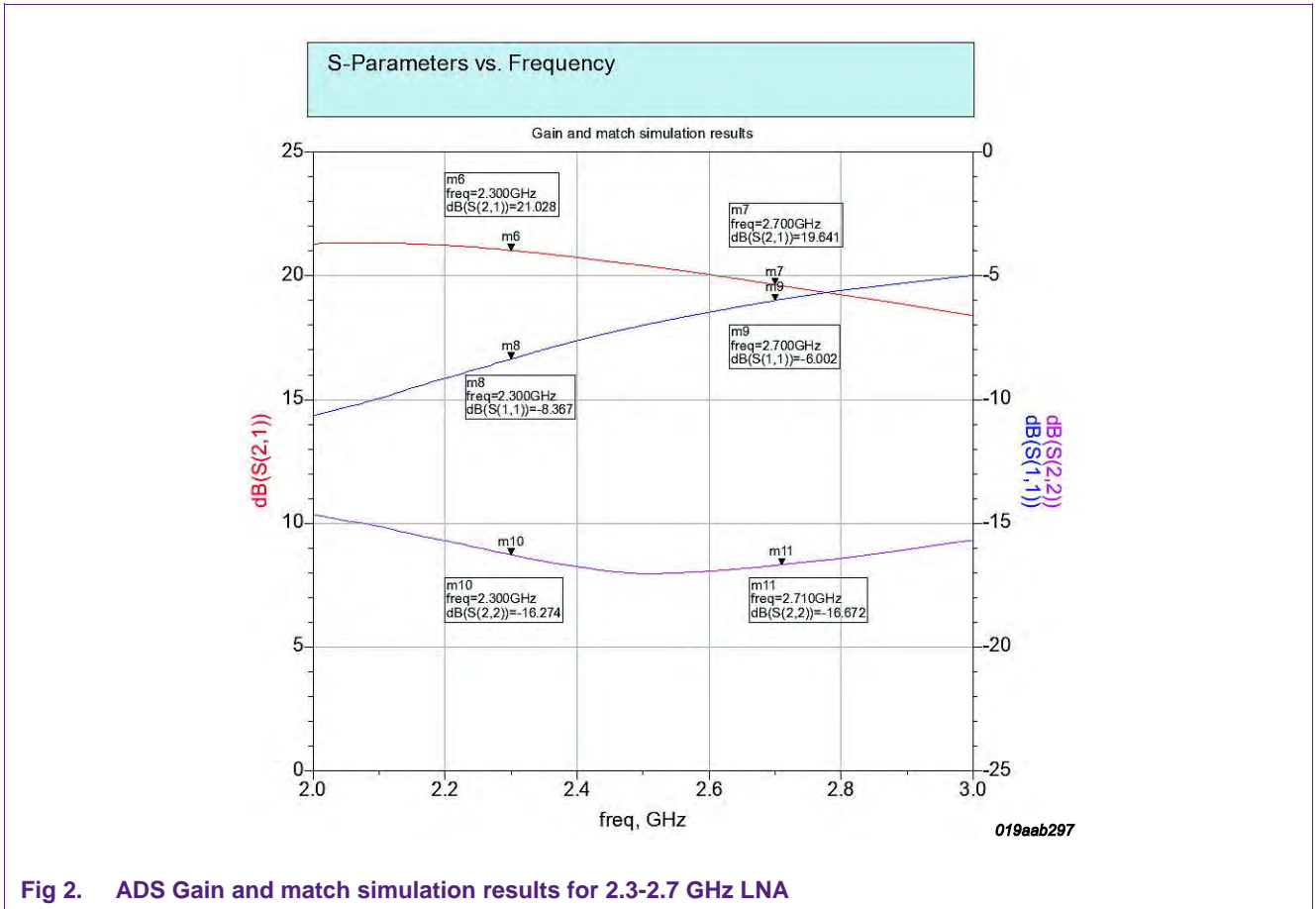
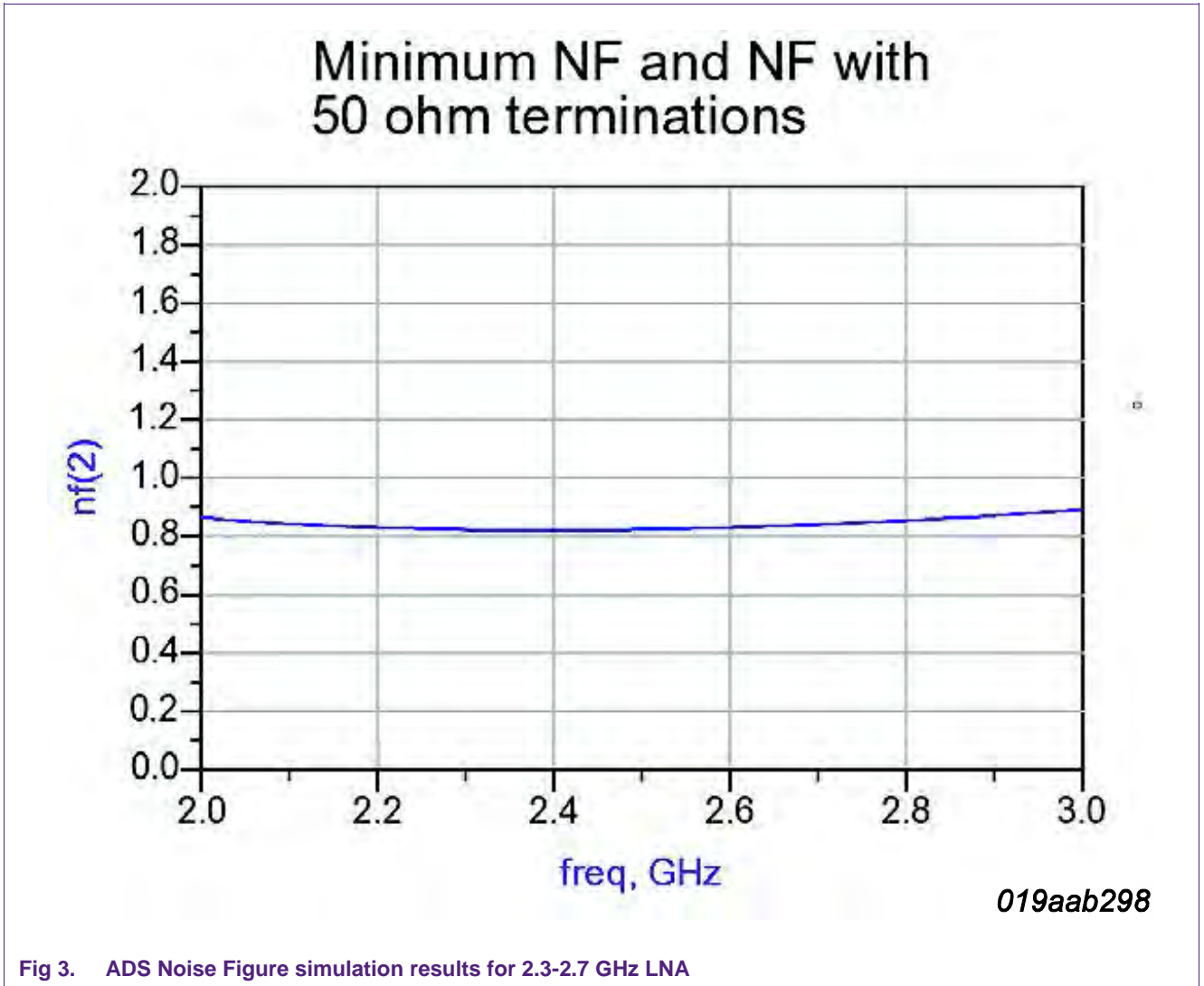

Fig 2. ADS Gain and match simulation results for 2.3-2.7 GHz LNA

3.3 BFU730F 2.3-2.7 GHz LNA - ADS NF simulation results



3.4 BFU730F 2.3-2.7 GHz LNA - ADS Stability simulation results

If either μ_{source} or μ_{load} is >1 , the circuit is unconditionally stable.

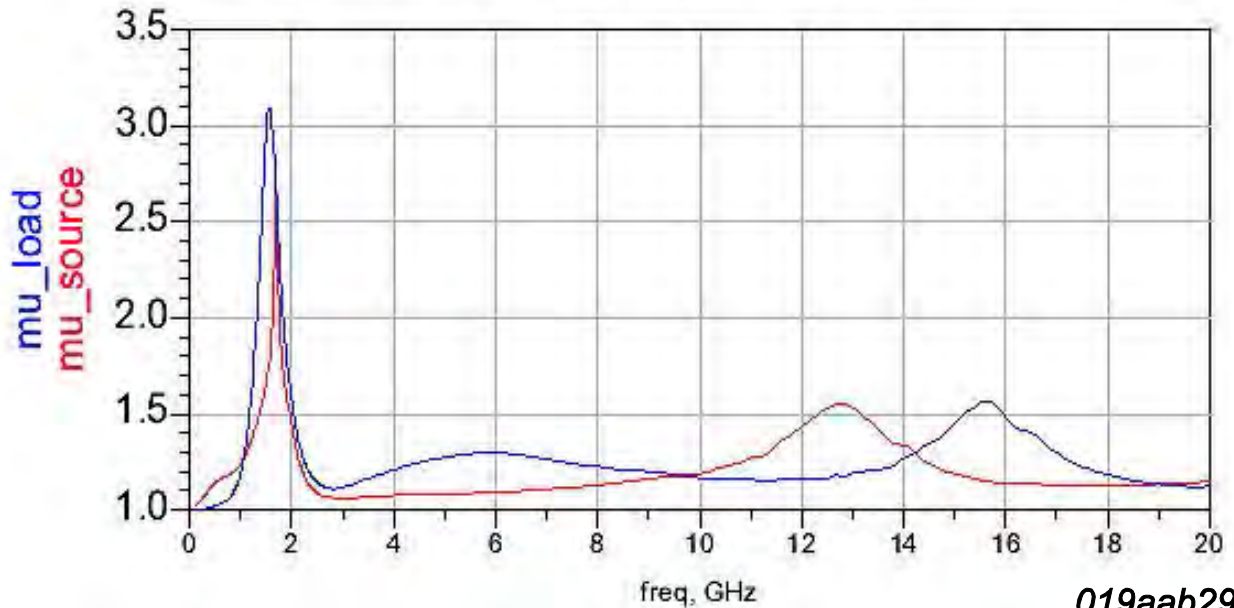

019aab299

(1) As $K \geq 1$ and $\mu \geq 1$, the LNA is unconditionally stable for the whole frequency band

Fig 4. ADS stability simulation results for 2.3-2.7 GHz LNA

4. Implementation

4.1 Schematic

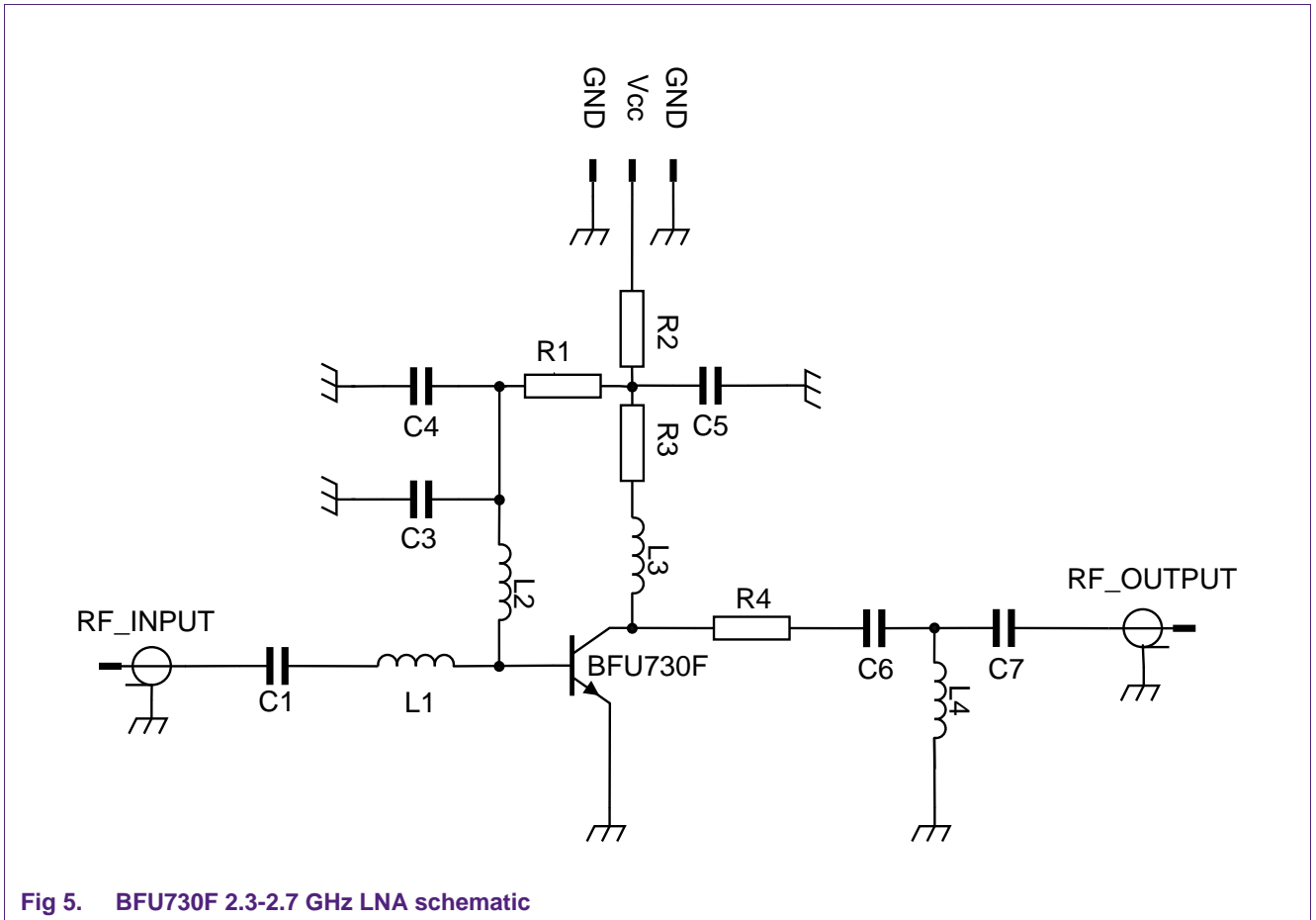

Fig 5. BFU730F 2.3-2.7 GHz LNA schematic

4.2 Layout and assembly

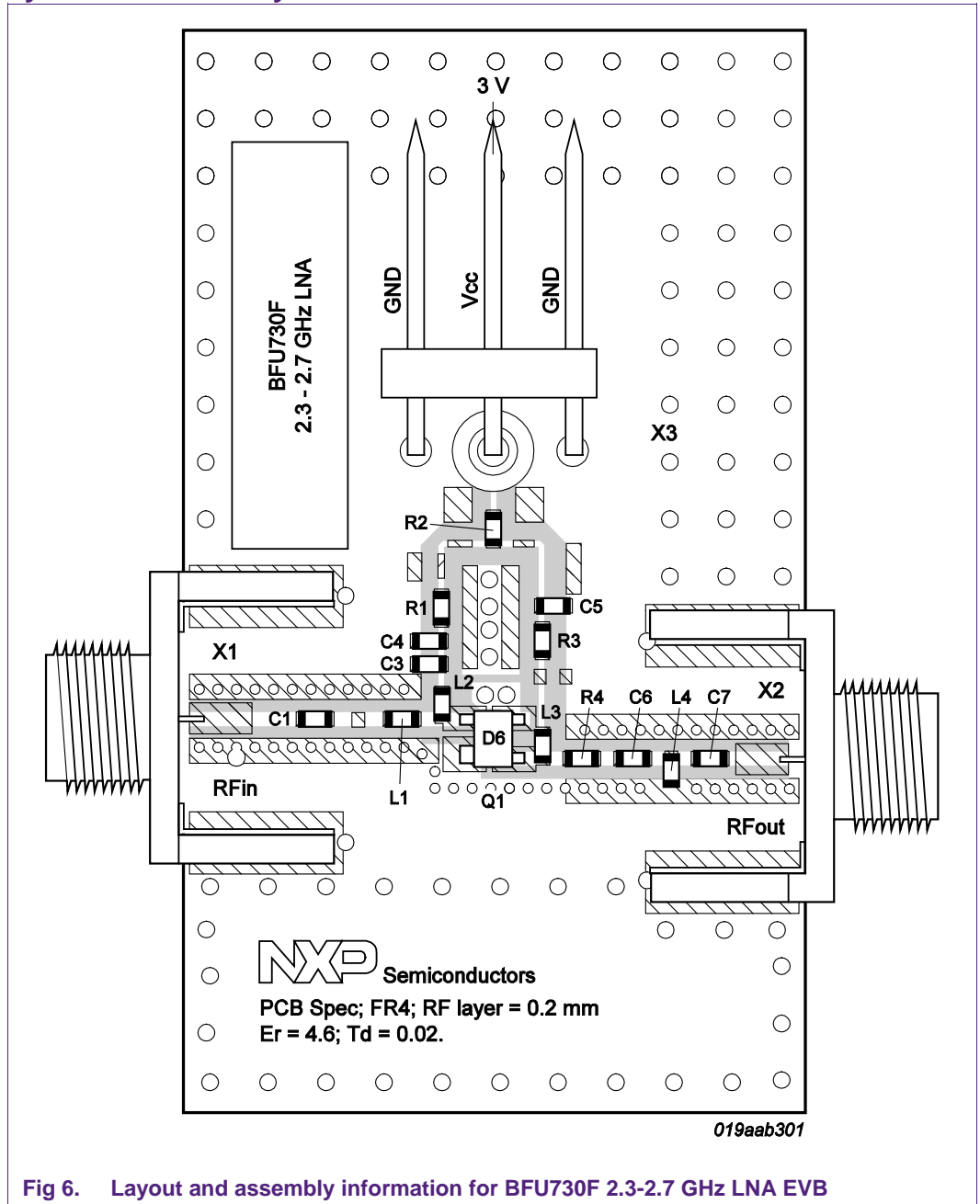

Table 2. Bill of materials

Designator	Description	Size	Value	Type	Note
Q1	BFU730F	2X2mm		NXP Semiconductors	HBT
PCB		20X35mm			
C1	Capacitor	0402	100 pF	MurataGRM1555	DC block
C3	Capacitor	0402	68 nF	MurataGRM1555	Bias Decoupling
C4	Capacitor	0402	6.8 pF	MurataGRM1555	Bias Decoupling
C5	Capacitor	0402	1 pF	MurataGRM1555	Bias Decoupling
C6	Capacitor	0402	3.3 pF	MurataGRM1555	output match
C7	Capacitor	0402	4.7 pF	MurataGRM1555	output match
L1	Inductor	0402	1.5 nH	Murata LQW15	input match
L2	Inductor	0402	8.7 nH	Murata LQW15	input match
L3	Inductor	0402	4.7 nH	Murata LQW15	output match
L4	Inductor	0402	3.6 nH	Murata LQP15	output match
R1	Resistor	0402	37 K		Bias Setting
R2	Resistor	0402	100 R		Bias Setting Hfe and Temp spread cancellation
R3	Resistor	0402	10 Ohm		Stability
R4	Resistor	0402	0 R		NA
X1,X2	SMA RF connector	-		Johnson, End launch SMA 142-0701-841	RF input/ RF output
X3	DC header	-		Molex, PCB header, Right Angle, 1 row, 3 way 90121- 0763	Bias connector

4.3 PCB layout

A good PCB Layout is an essential part of an RF circuit design. The EVB of the BFU730 can serve as a guideline for laying out a board using either the BFU730 or one of the other SiGe.C HBTs in the SOT343F package. Use controlled impedance lines for all high frequency inputs and outputs. Bypass V_{CC} with decoupling capacitors, preferable located as close as possible to the device. For long bias lines it may be necessary to add decoupling capacitors along the line further away from the device. Proper grounding the emitters is also essential for the performance. Either connect the emitters directly to the

ground plane ore through vias, or do both. The material that has been used for the EVB is FR4 using the stack shown in [Fig 7](#)

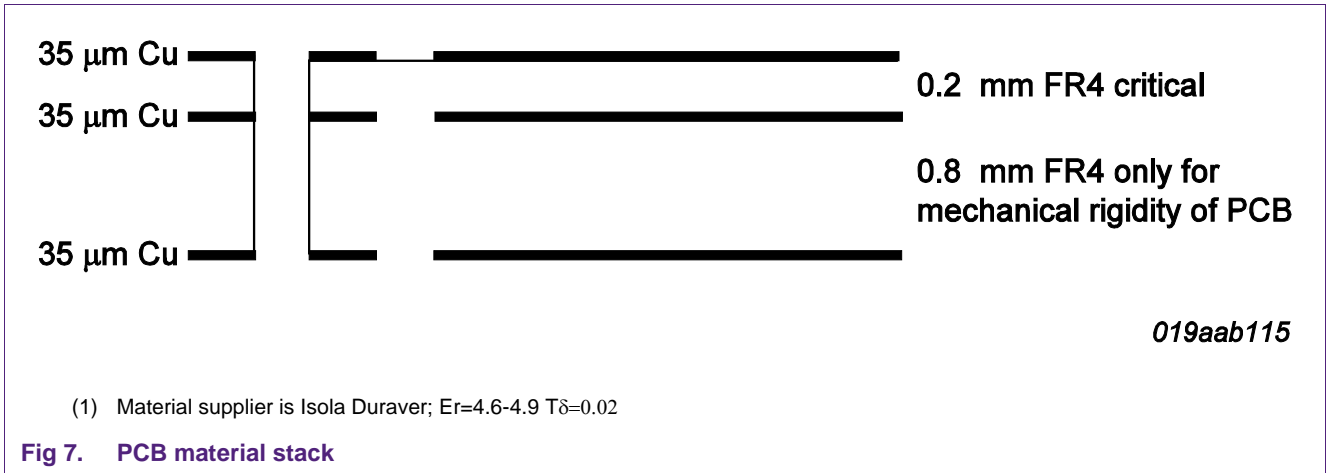

4.4 LNA View

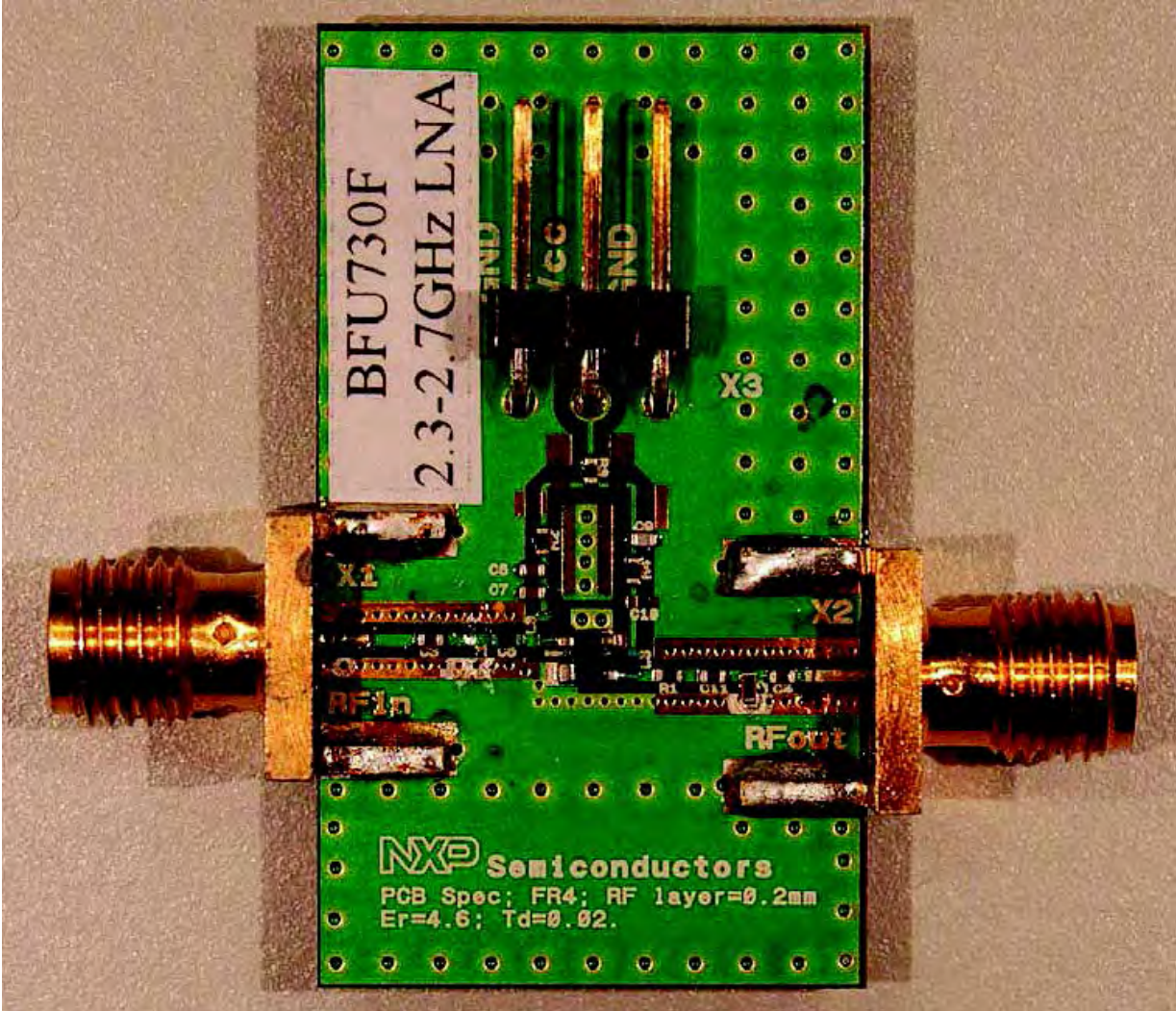

019aab302

Fig 8. 2.3_2.7 GHz LNA

4.5 Measurement results

Table 3. Typical measurement results measured on the evaluation board.

Temp=25 °C, frequency is 2.5GHz unless otherwise specified.

Parameter	Symbol	Value	Unit	Remarks
Supply Voltage	V_{cc}	3	V	
Supply Current	I_{cc}	10	mA	
Noise Figure	NF ^[1]	0.8	dB	
	2.3 GHz	21.2	dB	
Power Gain	G _P	2.5 GHz	21	dB
		2.7 GHz	20.5	dB
Input return Loss	IRL	7.9	dB	
Output return Loss	ORL	17.5	dB	
Input 1dB Gain compression Point	P _i 1dB	-16.5	dBm	
Output 1dB Gain compression Point	P _o 1dB	+3.7	dBm	
Input third order intercept point	IP _{3i}	+1.5	dBm	
Output third order intercept point	IP _{3o}	+22.5	dBm	
Power settling time	T _{on}	430	us	
	T _{off}	24	ns	

[1] The NF and gain figures are being measured at the SMA connectors of the evaluation board, so losses of the connectors and the PCB of approximately 0.1 dB are not subtracted

4.5.1 Faster Switching time <1 μs

If no switching speed is required in the application, the recommendation is to keep the BOM as is presented in this application note. However if the LNA is applied in e.g. a WLAN application where power settling time is required to be <1 μs, the value of C1 and C3 should be changed to 27pF. This will result in a T_{on} power settling time of 860ns and the T_{off} power settling time stays 24ns. However this change in capacitor values will result in about 5-10dB of degradation of the IP3 figures reported in [Table 3](#)

4.5.2 Gain and match - typical values

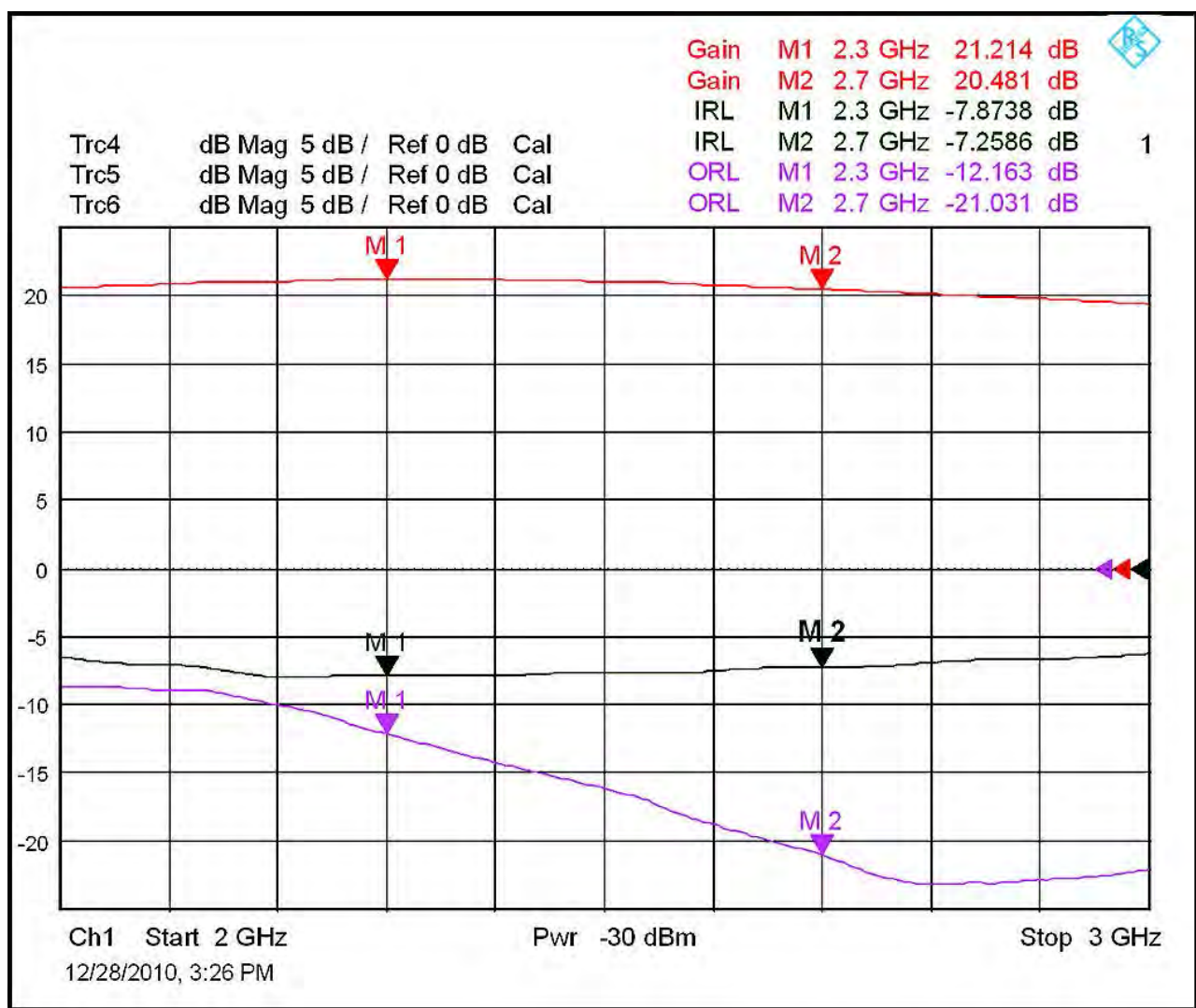
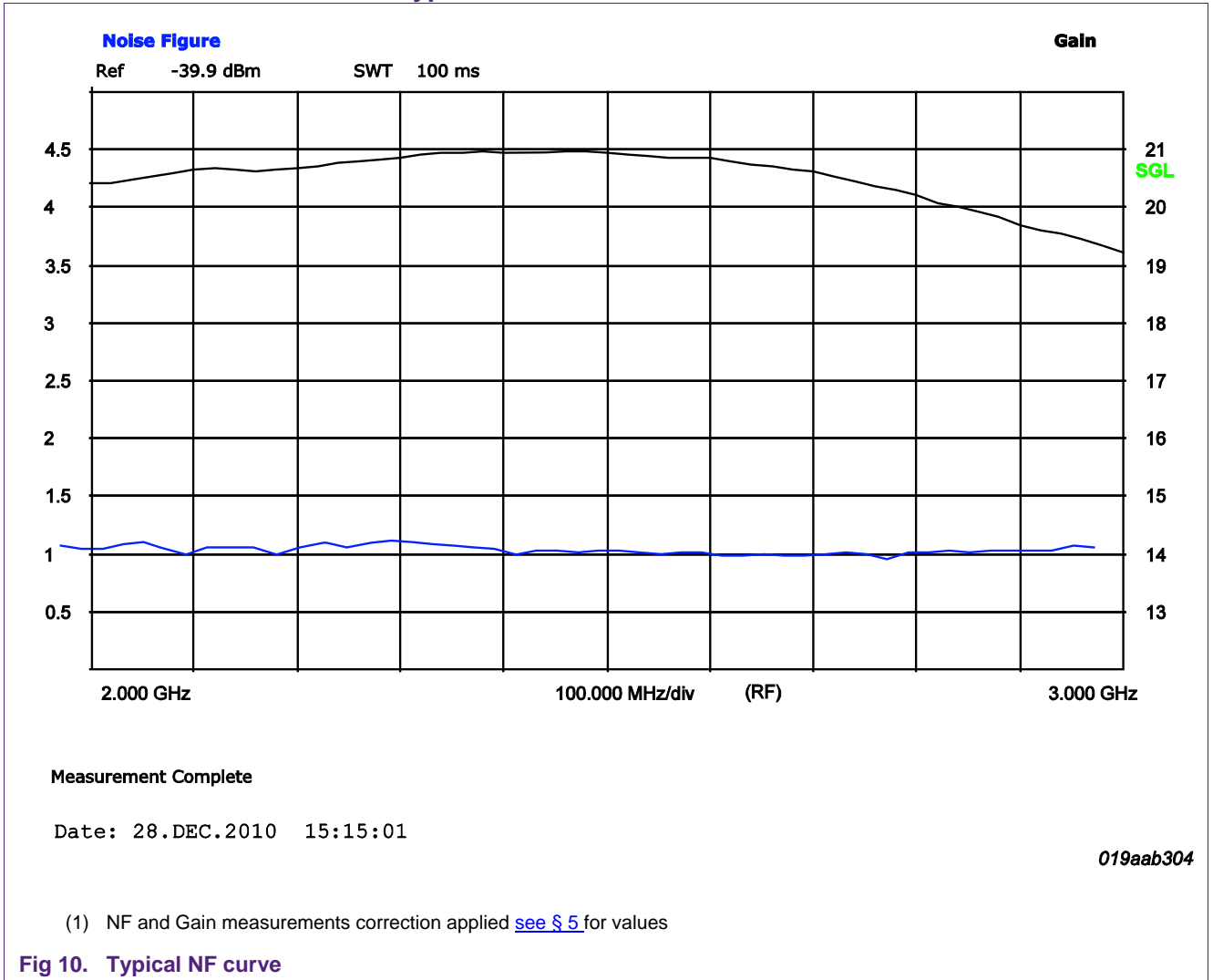

Fig 9. Typical Gain and match measured values

4.5.3 NF and Gain- typical values



4.5.4 Stability

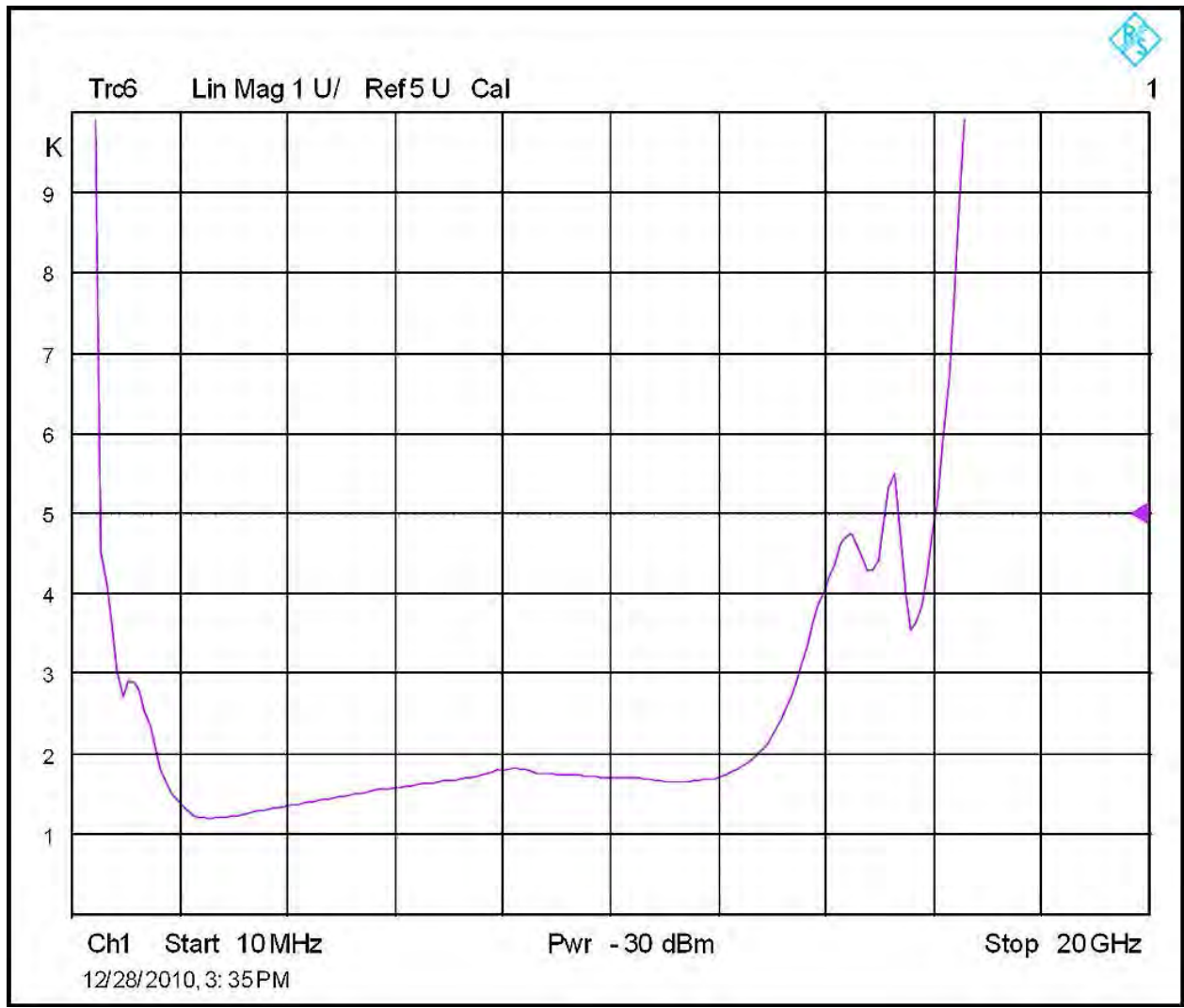
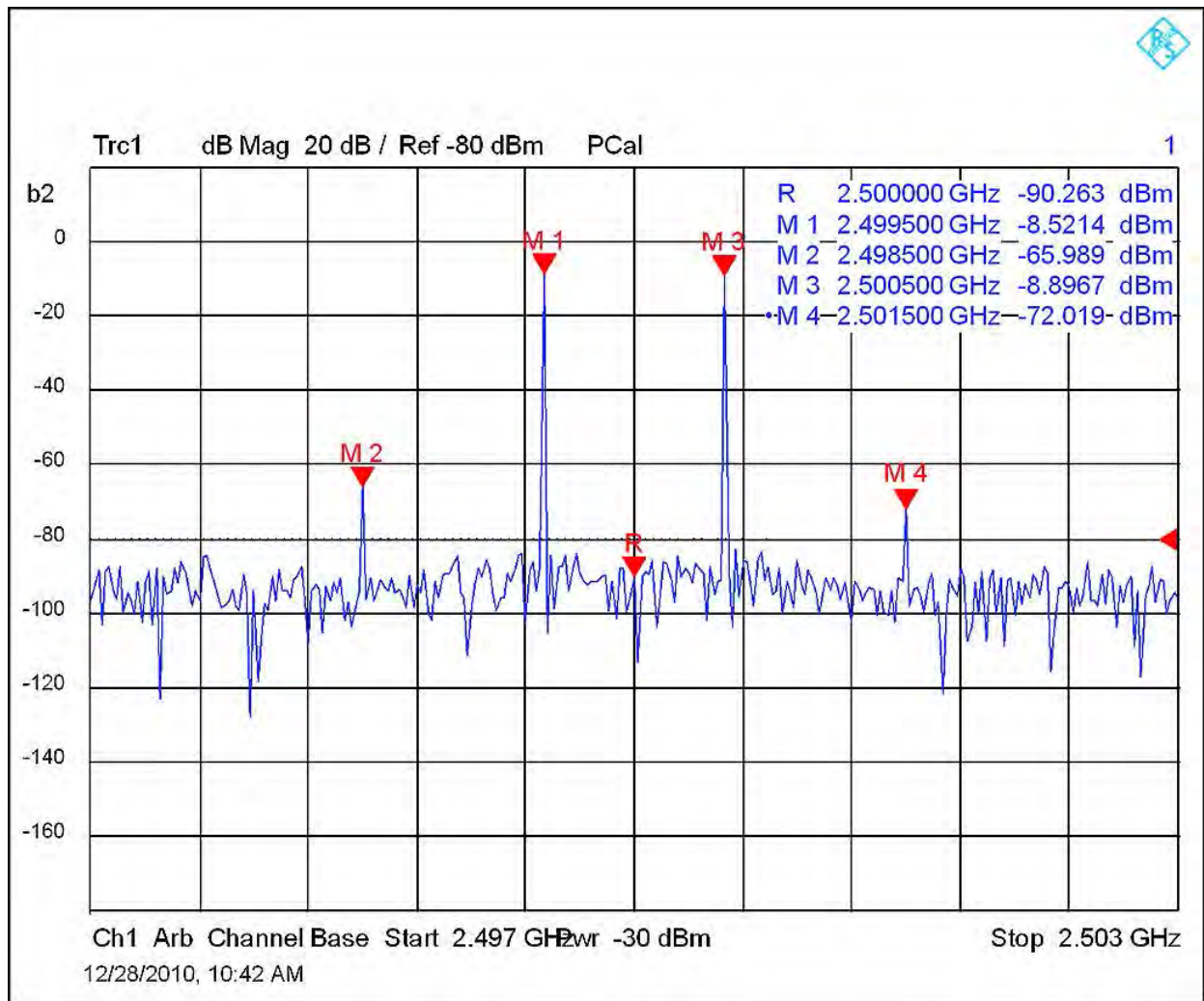

Fig 11. Stability typical measurement results

4.5.6 Linearity IP3 – typical values



019aab307

(1) $IP3_o = -8.9 + ((72 - 8.9) / 2) = +22.65$ dBm; $IP3_i = -30$ dBm + $63.1 / 2 = -30 + 31.55 = +1.55$ dBm

Fig 13. IM3 - typical values

4.5.7 Power settling time

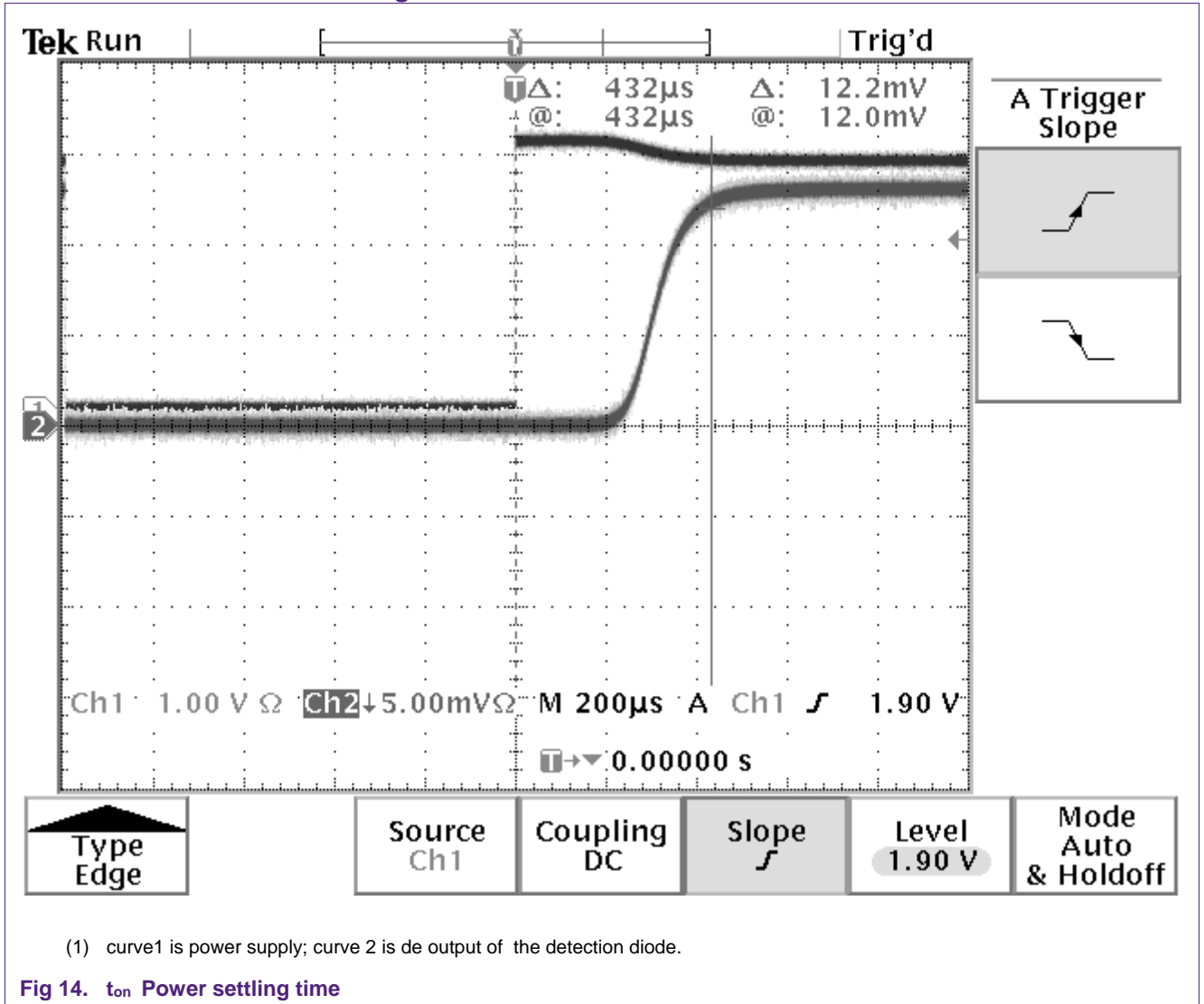

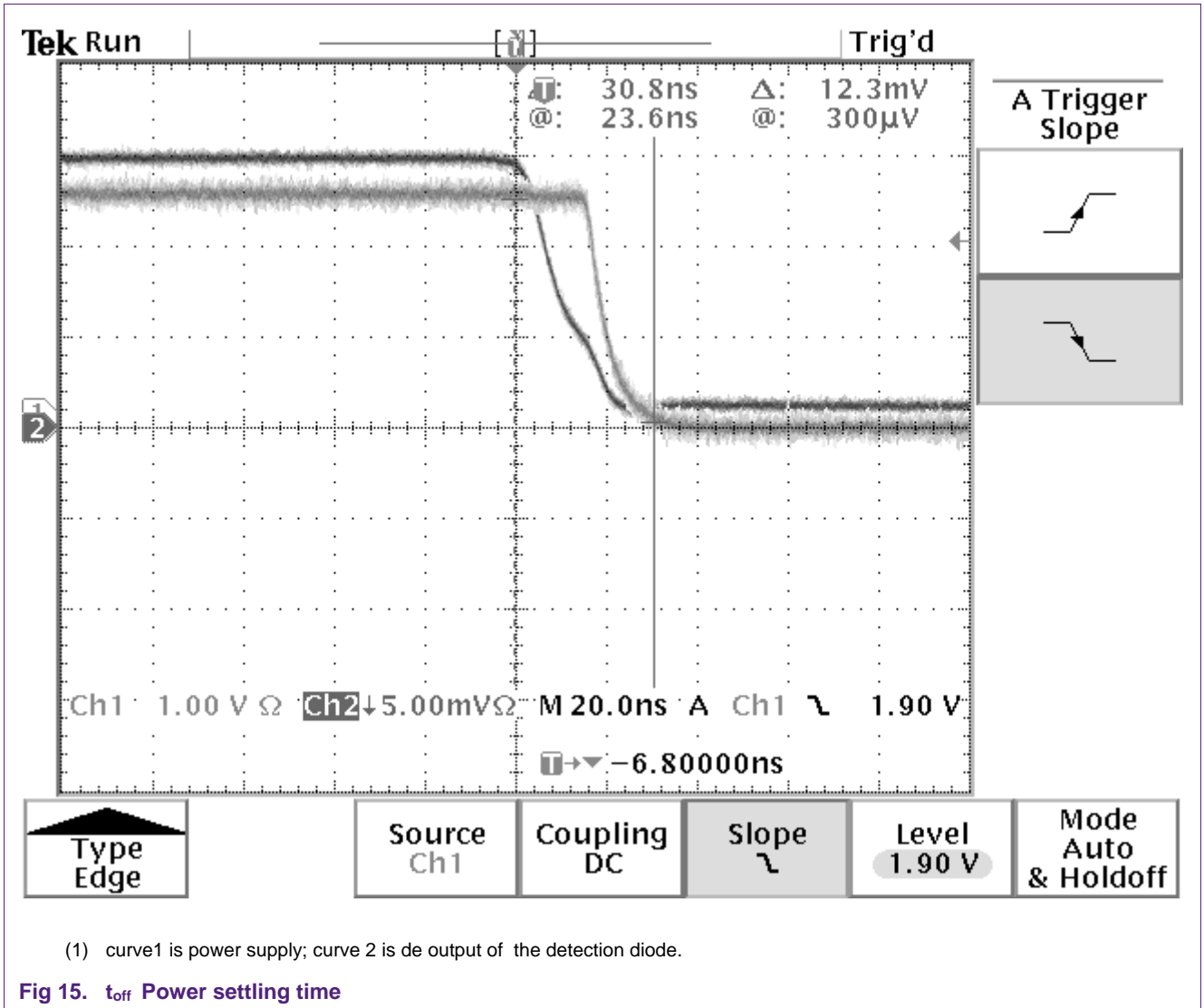

5. NF measurement corrections

There are two types of errors and losses that have been taken into account to correct the NF measurement results: (1) Own system error for NF measurement and (2) insertion losses accounted to RF IN and RF OUT connectors, microstrip feed lines used at the input of the LNA in NF measurements.

5.1 NF measurement system error

A Miteq professional amplifier, rated as NF=0.41 dB, Gain=30 dB, has been used as reference for NF measurement system correction. Its manufacturer data is in [Fig 16](#)

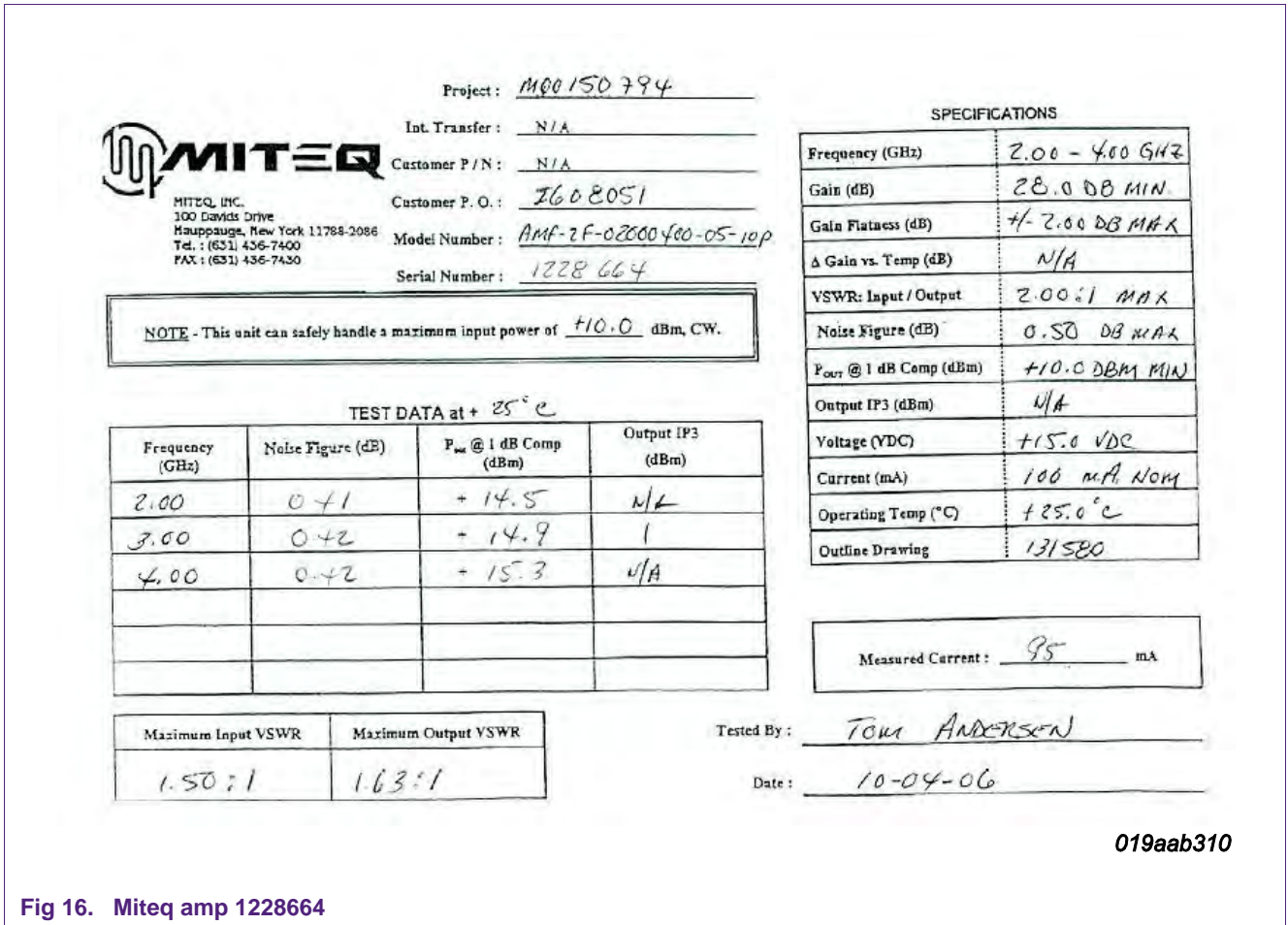

SPECIFICATIONS

Frequency (GHz)	2.00 - 4.00 GHz
Gain (dB)	28.0 DB MIN.
Gain Flatness (dB)	+/- 2.00 DB MAX
Δ Gain vs. Temp (dB)	N/A
VSWR: Input / Output	2.00:1 MAX
Noise Figure (dB)	0.50 DB MAX
P _{out} @ 1 dB Comp (dBm)	+10.0 DBM MIN
Output IP3 (dBm)	N/A
Voltage (VDC)	+15.0 VDC
Current (mA)	100 mA NOM
Operating Temp (°C)	+25.0° C
Outline Drawing	131580

Miteq 1228664 amplifier measured with the NF setup used to qualify the BFU730F 2.3-2.7GHz LNA has the NF performances listed in Fig 17. The system correction factor, NF_{sys}, is the difference between the NF measured and the 0.42 dB value from the catalog. At 2GHz this difference is about 0.3 dB and at 3 GHz around 0.15 dB.

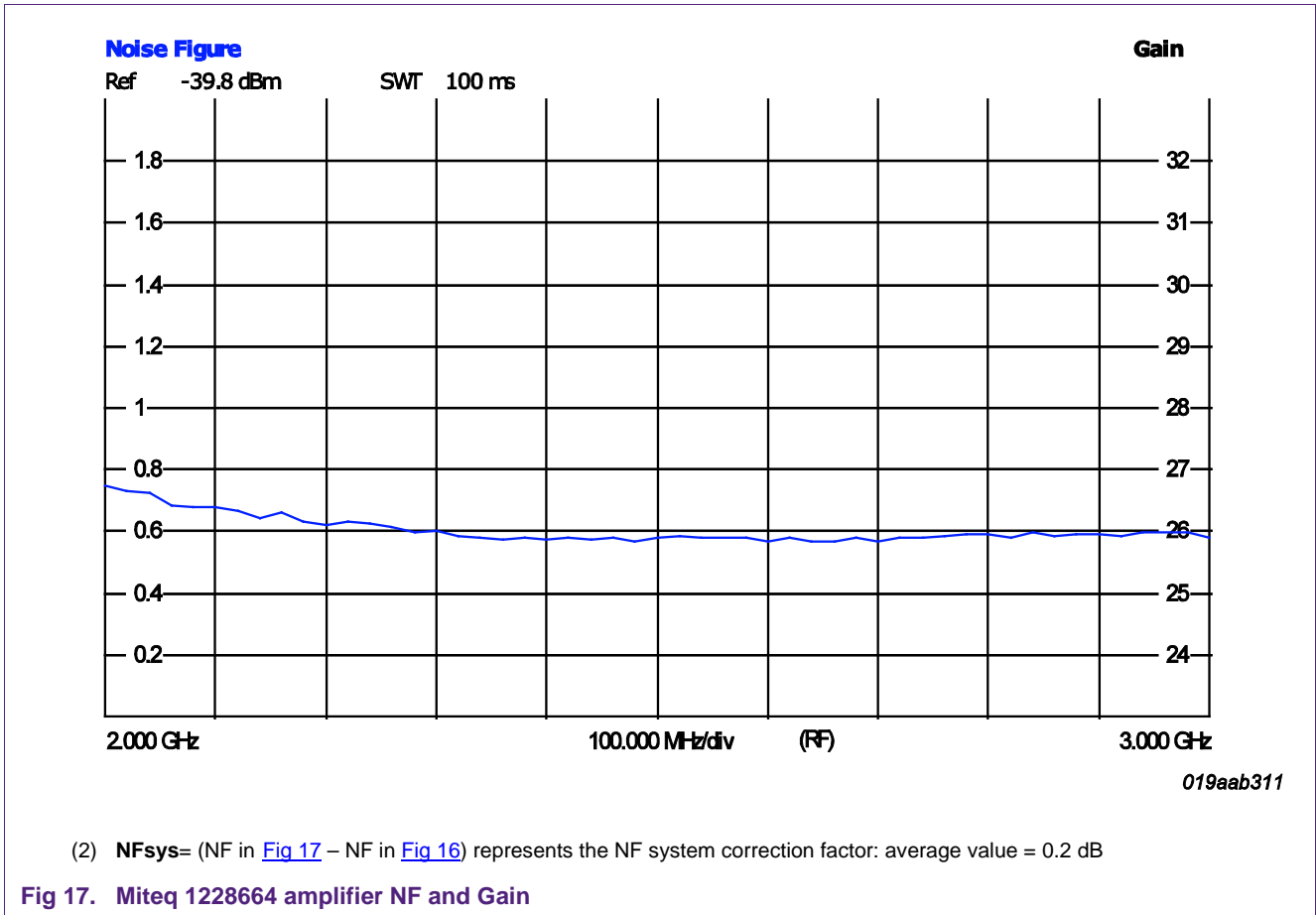

5.2 Insertion losses.

Insertion losses have not been taken in to account so measurements are referenced to the SMA connectors.

6. Legal information

6.1 Definitions

Draft — The document is a draft version only. The content is still under internal review and subject to formal approval, which may result in modifications or additions. NXP Semiconductors does not give any representations or warranties as to the accuracy or completeness of information included herein and shall have no liability for the consequences of use of such information.

6.2 Disclaimers

Limited warranty and liability — Information in this document is believed to be accurate and reliable. However, NXP Semiconductors does not give any representations or warranties, expressed or implied, as to the accuracy or completeness of such information and shall have no liability for the consequences of use of such information.

In no event shall NXP Semiconductors be liable for any indirect, incidental, punitive, special or consequential damages (including - without limitation - lost profits, lost savings, business interruption, costs related to the removal or replacement of any products or rework charges) whether or not such damages are based on tort (including negligence), warranty, breach of contract or any other legal theory.

Notwithstanding any damages that customer might incur for any reason whatsoever, NXP Semiconductors' aggregate and cumulative liability towards customer for the products described herein shall be limited in accordance with the Terms and conditions of commercial sale of NXP Semiconductors.

Right to make changes — NXP Semiconductors reserves the right to make changes to information published in this document, including without limitation specifications and product descriptions, at any time and without notice. This document supersedes and replaces all information supplied prior to the publication hereof.

Suitability for use — NXP Semiconductors products are not designed, authorized or warranted to be suitable for use in life support, life-critical or safety-critical systems or equipment, nor in applications where failure or malfunction of an NXP Semiconductors product can reasonably be expected to result in personal injury, death or severe property or environmental damage. NXP Semiconductors accepts no liability for inclusion and/or use of NXP Semiconductors products in such equipment or applications and therefore such inclusion and/or use is at the customer's own risk.

Applications — Applications that are described herein for any of these products are for illustrative purposes only. NXP Semiconductors makes no representation or warranty that such applications will be suitable for the specified use without further testing or modification.

Customers are responsible for the design and operation of their applications and products using NXP Semiconductors products, and NXP Semiconductors accepts no liability for any assistance with applications or customer product design. It is customer's sole responsibility to determine

whether the NXP Semiconductors product is suitable and fit for the customer's applications and products planned, as well as for the planned application and use of customer's third party customer(s). Customers should provide appropriate design and operating safeguards to minimize the risks associated with their applications and products.

NXP Semiconductors does not accept any liability related to any default, damage, costs or problem which is based on any weakness or default in the customer's applications or products, or the application or use by customer's third party customer(s). Customer is responsible for doing all necessary testing for the customer's applications and products using NXP Semiconductors products in order to avoid a default of the applications and the products or of the application or use by customer's third party customer(s). NXP does not accept any liability in this respect.

Export control — This document as well as the item(s) described herein may be subject to export control regulations. Export might require a prior authorization from national authorities.

Evaluation products — This product is provided on an "as is" and "with all faults" basis for evaluation purposes only. NXP Semiconductors, its affiliates and their suppliers expressly disclaim all warranties, whether express, implied or statutory, including but not limited to the implied warranties of non-infringement, merchantability and fitness for a particular purpose. The entire risk as to the quality, or arising out of the use or performance, of this product remains with customer.

In no event shall NXP Semiconductors, its affiliates or their suppliers be liable to customer for any special, indirect, consequential, punitive or incidental damages (including without limitation damages for loss of business, business interruption, loss of use, loss of data or information, and the like) arising out of the use of or inability to use the product, whether or not based on tort (including negligence), strict liability, breach of contract, breach of warranty or any other theory, even if advised of the possibility of such damages.

Notwithstanding any damages that customer might incur for any reason whatsoever (including without limitation, all damages referenced above and all direct or general damages), the entire liability of NXP Semiconductors, its affiliates and their suppliers and customer's exclusive remedy for all of the foregoing shall be limited to actual damages incurred by customer based on reasonable reliance up to the greater of the amount actually paid by customer for the product or five dollars (US\$5.00). The foregoing limitations, exclusions and disclaimers shall apply to the maximum extent permitted by applicable law, even if any remedy fails of its essential purpose.

6.3 Trademarks

Notice: All referenced brands, product names, service names and trademarks are property of their respective owners.

7. List of figures

Fig 1.	ADS simulation circuit for 2.3-2.7 GHz LNA.....	4
Fig 2.	ADS Gain and match simulation results for 2.3-2.7 GHz LNA.....	5
Fig 3.	ADS Noise Figure simulation results for 2.3-2.7 GHz LNA.....	6
Fig 4.	ADS stability simulation results for 2.3-2.7 GHz LNA.....	7
Fig 5.	BFU730F 2.3-2.7 GHz LNA schematic	8
Fig 6.	Layout and assembly information for BFU730F 2.3-2.7 GHz LNA EVB	9
Fig 7.	PCB material stack	11
Fig 8.	2.3_2.7 GHz LNA.....	12
Fig 9.	Typical Gain and match measured values	14
Fig 10.	Typical NF curve	15
Fig 11.	Stability typical measurement results.....	16
Fig 12.	Typical 1 dB compression point curve.	17
Fig 13.	IM3 - typical values	18
Fig 14.	t_{on} Power settling time	19
Fig 15.	t_{off} Power settling time	20
Fig 16.	Miteq amp 1228664	21
Fig 17.	Miteq 1228664 amplifier NF and Gain	22

8. List of tables

Table 1. Target spec.....3
Table 2. Bill of materials..... 10
Table 3. Typical measurement results measured on the
evaluation board. 13

9. Contents

1.	Introduction	3
2.	Requirements and design of the 2.3-2.7GHz GHz LNA.....	3
3.	Design	3
3.1	BFU730F 2.3-2.7 GHz LNA-ADS Simulation circuit.....	4
3.2	BFU730F 2.3-2.7 GHz LNA - ADS Gain and match simulation results.....	5
3.3	BFU730F 2.3-2.7 GHz LNA - ADS NF simulation results	6
3.4	BFU730F 2.3-2.7 GHz LNA - ADS Stability simulation results	7
4.	Implementation.....	8
4.1	Schematic	8
4.2	Layout and assembly	9
4.3	PCB layout	10
4.4	LNA View	12
4.5	Measurement results.....	13
4.5.1	Faster Switching time. <1 μ s.....	13
4.5.2	Gain and match - typical values	14
4.5.3	NF and Gain- typical values	15
4.5.4	Stability.....	16
4.5.5	1dB compression point typical values.	17
4.5.6	Linearity IP3 – typical values.....	18
4.5.7	Power settling time.....	19
5.	NF measurement corrections.....	20
5.1	NF measurement system error.....	20
5.2	Insertion losses.	22
6.	Legal information	23
6.1	Definitions	23
6.2	Disclaimers.....	23
6.3	Trademarks	23
7.	List of figures.....	24
8.	List of tables	25
9.	Contents.....	26

Please be aware that important notices concerning this document and the product(s) described herein, have been included in the section 'Legal information'.
