

REV	CHANGE	DATE	DRN	CHK
	Drawn	02/06/17	SJ	T

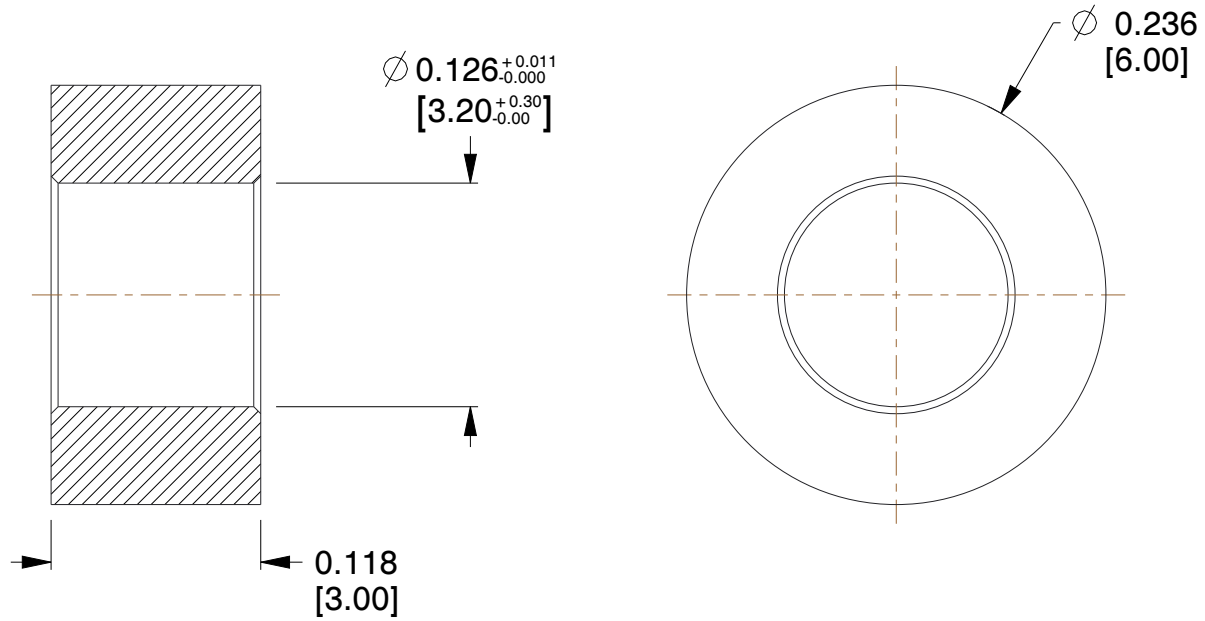
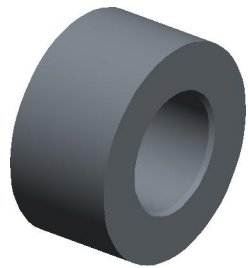

NOTES:

1. Material : Aluminum
2. Finish : No Plate
3. ASME Y14.5M - 2009
4. All Drawing Dimensions are in Inches [mm]
5. Unless otherwise specified; Edge Breaks, Radii or Countersinks 0.005-0.015

COMPONENT	SPACERS
M0532-3-AL 6MM ROUND SPACERS	SCALE
	9.25
	SHEET
	1 of 1



95 Silvermine Rd., Seymour CT 06483
 Tel: 203-888-2133, Fax: 203-888-9860

This Drawing is the Property of RAF.
 It contains confidential, proprietary information that is RAF property. Do not disclose to or duplicate for others except as authorized by RAF.

TOLERANCES
 ALL DIMENSIONS ARE INCHES (UNLESS OTHERWISE SPECIFIED)
METALLIC
 LENGTHS ≤ 6 INCHES ± 0.005
 LENGTH > 6 INCHES ± 0.010
 DIAMETERS: ± 0.005
NON-METALLIC
 LENGTH: ± 0.010 DIAMETERS: ± 0.010
INTERNAL THREADS:
 MINIMUM THREAD DEPTH